



ATTIVA

ATTIVA



ATTIVA

by PIETRO LOVATO

Con Attiva la seduta direzionale incontra la sedia da ufficio, grazie all'alto livello di qualità e dettaglio. Il suo aspetto raffinato deriva da finiture cromate lucide e da un design pulito, che si abbina al comfort di due opzioni braccioli e altrettante di schienale, in rete o imbottito.

With Attiva, executive seating meets task chair thanks to the high level of quality and detail. Its refined look provided by the polished chromed finishings and the clean design match comfort of two armrest option and two backrest options, mesh or upholstered.

Girevole. Sedile con sistema di molle.
Schienale medio o alto. Poggiatesta opzionale.

*Swivel. Seat with spring system.
Medium or high backrest. Optional headrest.*

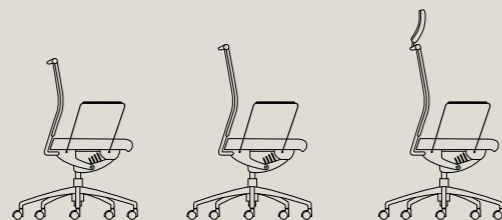

M

42



CUSCINO EXTRA COMFORT
EXTRA-COMFORT CUSHION

43



ATTIVA



M
45

ATTIVA



ATTIVA

Medium

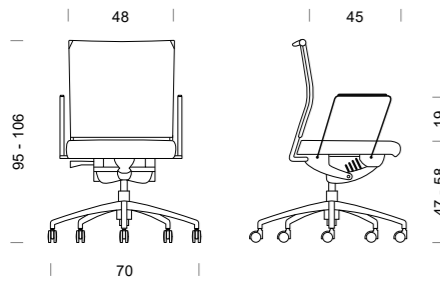

High

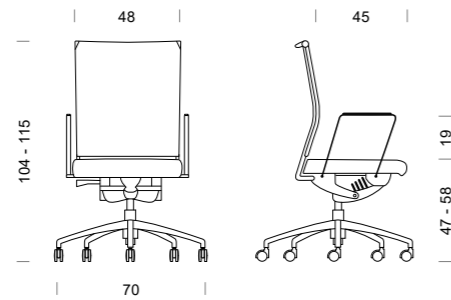

High+headrest

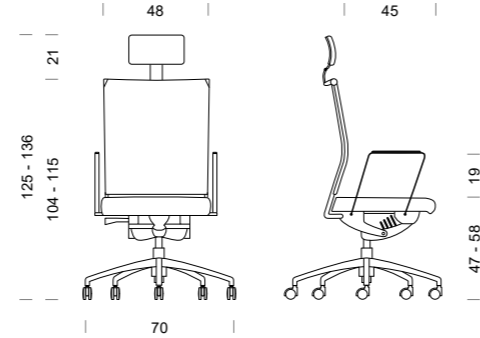

ATTIVA



A Pressione sullo schienale di spalle e scapole
Shoulders and scapulas pressure on backrest
Pression des épaules et omoplates sur le dossier
Druck von der Schulter und Schulterblatt auf der Rückenlehne
Presión en la parte posterior de los hombros y omóplatos

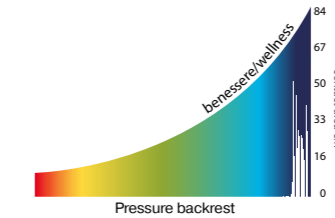

B Pressione dell'area sacrale su supporto lombare
Sacrum pressure on lumbar support
Pression sacrale sur le soutien lombaire
Druck im Bereich Kreuzbein und Lendenwirbelstütze
Presión del área sacra sobre soporte lumbar

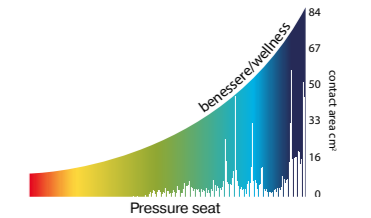

C Pressione di bacino e cosce sul sedile
Hip and thigh pressure on seat
Pression des cuisses et du bassin sur l'assise
Druck im Becken und Oberschenkel auf dem Sitz
Presión de pelvis y muslos en el asiento

SCHIENALE: Schienale in tubo sagomato d'acciaio, Ø 25mm, finitura cromata (15µm) rivestita in rete o imbottita con spugna e rivestita in tessuto.

BACKREST: Ø25mm shaped steel tube backrest, chromed finish (15µm), mesh upholstered or foam padded and fabric upholstery.

DOSSIER: Dossier en tube d'acier formé, Ø 25mm, finition chromé (15µm), revêtue en résille ou rembourrée de mousse et tapissée.

RÜCKENLEHNE: Ø25mm geformte Stahlrohr Rückenlehne-verchromt (15 µm), Netzrücken oder gepolsterten Schaumstoff.

RESPALDO: Parte posterior en tubo de acero con forma, Ø 25 mm, acabado cromado (15 µm) en malla o acolchado con espuma y tapizado.

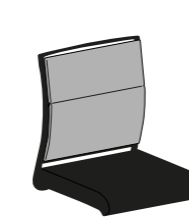
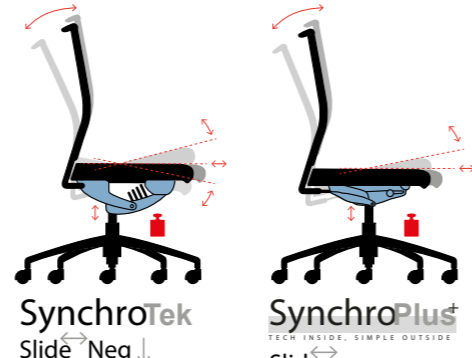

XC013
medium cushion

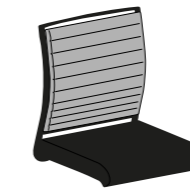

XC021
medium cushion

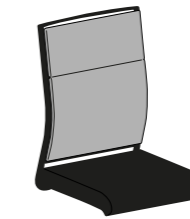

XC012
high cushion

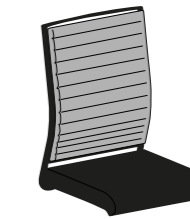

XC020
high cushion



5-spoke
aluminium base



5-spoke
iron base



XB001
metal arm.



XB002
metal arm. uph. pad



XB092 - 3D

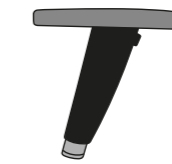

XB087
chromed 3D soft pad



XB089 - 4D
extra soft pad

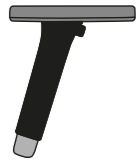

XB090 - chromed 4D
extra soft pad



Ø 50 mm
soft self-braking,
chromed finish



Ø 65 mm
soft self-braking,
black finish



Ø 65 mm
self-braking
perforated

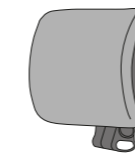

XT001
headrest

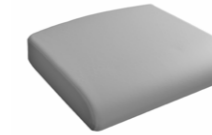

XD018
comfort seat



XM007
seat with negative inclination
ONLY for SYNCHRO PLUS

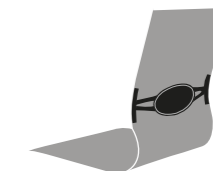

XR006
lumbar support

