

CRONO



CRONO



CRONO

by PIETRO LOVATO



Crono è una seduta di pregio, che emana autorevolezza e solidità. Confortevole nella seduta e sobria nel design, mette al centro la personalizzazione grazie a una manopola dietro allo schienale che ne regola l'altezza, adattando il supporto lombare.

Crono is a high-quality office chair that exudes prestige and stability. With a comfortable seat and a timeless design, it focuses on personalisation thanks to a back knob that adjusts the backrest height, thus adapting the lumbar support.

Girevole, imbottita.
Poggiatesta opzionale.

*Swivel, upholstered.
Optional headrest.*



M



CUSCINO EXTRA COMFORT
EXTRA-COMFORT CUSHION



CRONO



CRONO

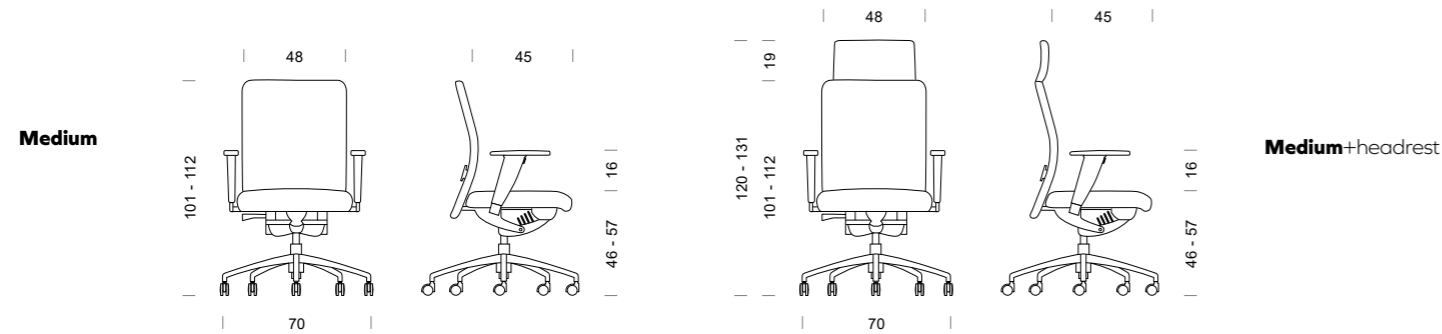

SCHIENALE: Schienale regolabile in altezza (6cm) in spugna schiumata a freddo con struttura portante in tubo tondo d'acciaio, Ø 20mm, con molle greche, rivestita.

BACKREST: Height adjustable backrest (6cm) cold injected foam padding monocoque, Ø 20mm steel tube structure, with metal springs, upholstered.

DOSSIER: Dossier réglable en hauteur (6cm) en mousse moulée à froids avec châssis en tube d'acier rond, Ø 20mm, ressorts nosag, tapissée.

RÜCKENLEHNE: Kaltgeschäumte, höhenverst. Polyurethan Rückenl. (6cm). Ø 20mm Stahlrohr Struktur, Metallfedern.

RESPALDO: Respaldo ajustable en altura (6 cm) en espuma inyectada a frío con estructura de soporte en tubo de acero redondo, Ø 20 mm, resortes zig-zag, tapizado.

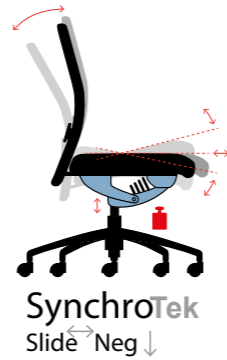

A Pressione sullo schienale di spalle e scapole
Shoulders and scapulas pressure on backrest
Pression des épaules et omoplates sur le dossier
Druck von der Schulter und Schulterblatt auf der Rückenlehne
Presión en la parte posterior de los hombros y omóplatas

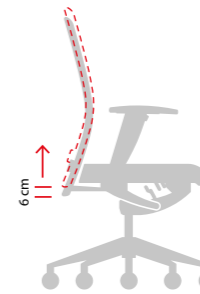

Schienale regolabile in altezza
Height adjustable backrest
Dossier réglable en hauteur
Höhenverst. schwarz
Respaldo ajustable en altura

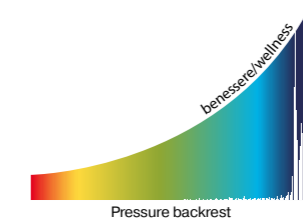

B Pressione dell'area sacrale su supporto lombare
Sacrum pressure on lumbar support
Pression sacrale sur le soutien lombaire
Druck im Bereich Kreuzbein und Lendenwirbelstütze
Presión del área sacra sobre soporte lumbar

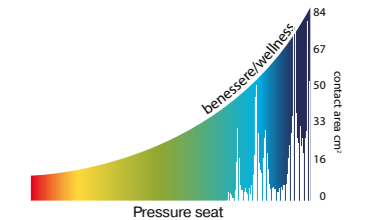

C Pressione di bacino e cosce sul sedile
Hip and thigh pressure on seat
Pression des cuisses et du bassin sur l'assise
Druck im Becken und Oberschenkel auf dem Sitz
Presión de pelvis y muslos en el asiento



5-spoke aluminium base



5-spoke polyamide base



Ø 50 mm self-braking black finish



Ø 50 mm soft self-braking black finish



Ø 65 mm soft self-braking black finish



XB001 metal arm.



XB002 metal arm. uph. pad

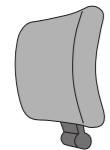

XT015 headrest

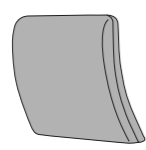

XT002 headrest

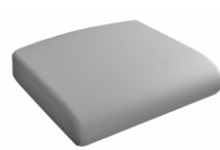

XD018 comfort seat

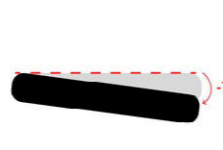

XM007 seat with negative inclination ONLY for SYNCHRO PLUS



XD001 seat with springs



XB018 2D



XB025 2D soft pad



XB092 3D



XB020 - 2D
XB021 - 3D

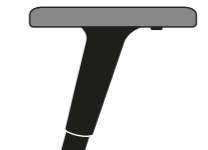

XB022 - 2D soft pad
XB023 - 3D soft pad

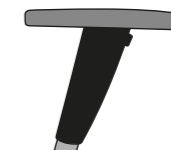

XB087 chromed 3D soft pad

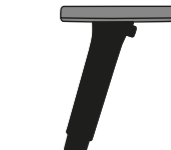

XB089 4D extra soft pad

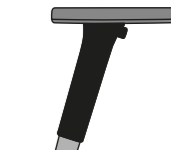

XB090 chromed 4D extra soft pad

