

CONTRACT

Pricelist 06/2025
REV.14 14-10

index

 MOVING

- 6 CARDINALE
- 10 CARMEN
- 14 HOOP
- 18 TOSCA
- 22 IRIS
- 26 CUBIX
- 30 GIUNONE
- 34 DAFNE
- 40 SLIM **Fixed**
- 44 SLIM **Stool**
- 48 SLIM **Swivel**
- 52 SLIM **Task**
- 53 SLIM **Task Stool**
- 56 SLIM **Bench**
- 62 ISY
- 66 SLIM **Attachable**
- 70 ELETTRA
- 74 ZIP
- 80 ECOCHAIR
- 86 FLEXA
- 90 DAMA
- 94 PRETTY
- 98 PRETTY **SPORT**
- 102 PILATUS
- 108 EDGAR
- 112 NABUCCO
- 116 OTELLO

CARDINALE

idea: *Pietro Lovato*



1. SCOCCA:

Monoscocca in spugna schiumata a freddo con struttura portante in tubo tondo d'acciaio, Ø16mm, rivestita

2. MECCANISMO:

Molla oscillante in alluminio cromato

3. GAS:

Altezza fissa, rotazione, finitura cromata

4. BASE:

- Base 4 razze in alluminio, Ø730mm, finitura lucida
- Base 4 razze in ferro, Ø720mm, finitura cromata (15µm)
- Base a disco in lastra d'acciaio, Ø600mm, finitura cromata (15µm)
- Base a disco in lastra d'acciaio, Ø480mm, finitura cromata (15µm)

5. PIEDINI:

- Piedini in polimero termoplastico, h. 25mm, finitura cromata (15µm)
- Piedini in polimero termoplastico, h. 40mm, finitura cromata (15µm)

1. SHELL :

Cold injected foam padding monocoque, Ø16mm steel tube structure, upholstery

2. MECHANISM:

Aluminium chromed tilting spring

3. GAS LIFT:

Not height adjustable, chromed finish

4. BASE:

- Polished aluminium 4 spoke base, Ø730 mm
- Iron 4 spoke base, Ø720 mm chromed finish (15µm)
- Round base, Ø600mm steel plate chromed finish (15µm)
- Round base, Ø480mm steel plate, chromed finish (15µm)

5. FEET:

- h.25mm Thermoplastic polymer gliders chromed finish (15µm)
- h.40mm Thermoplastic polymer gliders, chromed finish (15µm)

1. COQUE:

Monocoque en mousse moulée à froids avec châssis en tube d'acier rond, Ø16mm, tapissée

2. MECANISME:

Ressort basculant en aluminium poli

3. VERIN A GAZ:

Hauteur fixe, pivotant, finition chromé

4. PIÈTEMENT:

- Piètement 4 branches alu poli, Ø730mm
- Piètement 4 branches en métal, Ø720mm, finition chromé (15µm)
- Piètement disque en acier Ø600mm, finition chromé (15µm)
- Piètement disque en acier Ø480mm, finition chromé (15µm)

5. PATINS:

- Patins polymère thermoplastique, h.25mm, finition chromée (15µm)
- Patins polymère thermoplastique, h.40mm, finition chromée (15µm)

1. SCHALE :

Stahlrohrschale, Ø16mm, ausgepolstert mit kaltgeschäumten Polyurethan und Bezug

2. MECHANIK :

Aluminium polierte Feder Wippmechanik

3. GASFEDER :

Ohne Sitzhöhenverstellung, drehbar, verchromt

4. GESTELL :

- 4-Stern Alu poliertes Fußkreuz, Ø730 mm
- 4-Stern Eisen Fußkreuz, Ø720mm verchromt (15µm)
- Stahlplatte Tellerfuß, Ø600mm, verchromt (15µm)
- Stahlplatte Tellerfuß, Ø480mm, verchromt (15µm)

5. GLEITER :

- Thermoplastische Polymergleiter, H.25mm, verchromt (15µm)
- Thermoplastische Polymergleiter, H.40mm, verchromt (15µm)

1. CASCO:

Monocasco en espuma inyectada a frío con estructura de soporte en tubo de acero redondo, Ø16mm, tapizado

2. MECANISMO:

Muelle oscilante en aluminio cromado

3. GAS:

Altura fija, rotación, acabado cromado.

4. BASE:

- Base de 4 estrellas en aluminio, Ø730mm, acabado brillante.
- Base de 4 estrellas en hierro, Ø720mm, acabado cromado (15µm)
- Base del disco en chapa de acero, Ø600 mm, acabado cromado (15µm)
- Base del disco en chapa de acero, Ø480 mm, acabado cromado (15µm)

5. PIES:

- Pies en polímero termoplástico, h. 25 mm, acabado cromado (15µm)
- Pies en polímero termoplástico, h. 40 mm, acabado cromado (15µm)



CARDINALE

SCocca IN POLIURETANO, STRUTTURA IN METALLO
 POLYURETANE SCHELL, METAL STRUCTURE
 COQUE EN POLYURETHANE, STRUCTURE EN METAL
 POLYURETHANSCHALE, METALLSTRUKTUR
 CONCHA EN POLIURETANO, ESTRUCTURA EN METAL

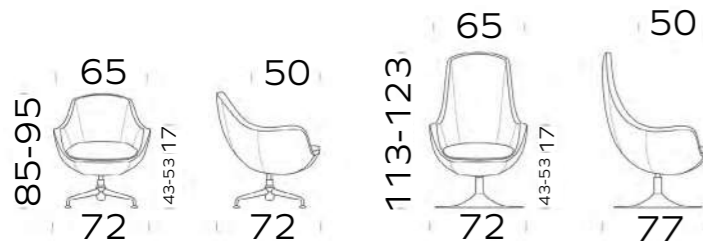

Mechanism: **SeatPlate**↑↓



Regolazione altezza
 Height adjustment
 Réglage en hauteur
 Höhenverstellung
 Ajuste de altura

CARDINALE



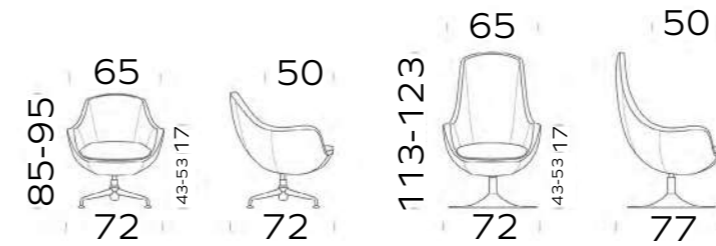





SCocca IN POLIURETANO, STRUTTURA IN METALLO
 POLYURETANE SCHELL, METAL STRUCTURE
 COQUE EN POLYURETHANE, STRUCTURE EN METAL
 POLYURETHANSCHALE, METALLSTRUKTUR
 CONCHA EN POLIURETANO, ESTRUCTURA EN METAL











Mechanism: **Tilting**



Blocco oscillante, Regolazione altezza/tensione
 (Un-)locking device, Height/tension adjustment
 Système de blocage-débloccage de l'oscillation, Réglage en hauteur/ d'intensité
 Blockierung der Rückenlehnen /Spannungsregler / Höhenverstellung
 Sistema de bloqueo-desbloqueo del respaldo, Ajuste de altura/tensión

BASE BASE PIÈTEMENT GESTELL BASE	RUOTA/PIEDINO CASTOR/FEET ROULETTES/PATINS ROLLEN/GLEITER RUEDAS/PIES	STRUTTURA STRUCTURE STRUCTURE STRUKTUR ESTRUCTURA	SCHIENALE BACKREST DOSSIER RÜCKENLEHNE RESPALDO	CODICE CODE CODE ARTIKEL CÓDIGO	KG	TESSUTI/FINITURE UPHOLSTERIES/FINISHING REVETEMENTS STOFFGRUPPE TAPICERÍAS			
						D	E	F	G
 base disco round base piètement disque en acier Stahlplate Tellerfuß base del disco	 feltrini felts feutres Filzgleiter fieltros		Medium	CA0051	17,70	1024	1055	1080	1288
			High	CA0052	20,50	1145	1179	1208	1430
			Medium	CA0085	17,70	941	972	997	1205
			High	CA0086	20,50	1005	1039	1068	1290
 4 razze in ferro 4-spoke iron 4 branches en métal 4-Stern es Eisen Fußkreuz estrella en metal	 In tono Coordinated En teinte Je Farbton A juego		Medium	CA0057	16,10	1023	1050	1073	1248
			High	CA0058	16,60	1124	1154	1177	1370
			Medium	CA0059	16,10	967	994	1017	1192
			High	CA0060	16,60	1068	1098	1121	1314

BASE BASE PIÈTEMENT GESTELL BASE	RUOTA/PIEDINO CASTOR/FEET ROULETTES/PATINS ROLLEN/GLEITER RUEDAS/PIES	STRUTTURA STRUCTURE STRUCTURE STRUKTUR ESTRUCTURA	SCHIENALE BACKREST DOSSIER RÜCKENLEHNE RESPALDO	CODICE CODE CODE ARTIKEL CÓDIGO	KG	TESSUTI/FINITURE UPHOLSTERIES/FINISHING REVETEMENTS STOFFGRUPPE TAPICERÍAS			
						D	E	F	G
 base disco round base piètement disque en acier Stahlplate Tellerfuß base del disco	 feltrini felts feutres Filzgleiter fieltros		Medium	CA0075	17,50	1139	1171	1198	1403
			High	CA0076	20,30	1258	1293	1321	1547
			Medium	CA0077	17,50	1056	1088	1115	1320
			High	CA0078	20,30	1118	1153	1181	1407
 4 razze in ferro 4-spoke iron 4 branches en métal 4-Stern es Eisen Fußkreuz estrella en metal	 In tono Coordinated En teinte Je Farbton A juego		Medium	CA0081	15,90	1135	1150	1172	1470
			High	CA0082	16,30	1225	1256	1280	1506
			Medium	CA0083	15,90	1079	1094	1116	1414
			High	CA0084	16,30	1169	1200	1224	1492

* DISPONIBILE ANCHE IN
 ALSO AVAILABLE
 ÉGALEMENT DISPONIBLE EN
 ERHÄLTlich AUCH IN
 TAMBIÉN DISPONIBLE EN



RAL 9016



RAL 1012



RAL 3012



RAL 6021



RAL 7032



RAL 7046

* DISPONIBILE ANCHE IN
 ALSO AVAILABLE
 ÉGALEMENT DISPONIBLE EN
 ERHÄLTlich AUCH IN
 TAMBIÉN DISPONIBLE EN



RAL 9016



RAL 1012



RAL 3012



RAL 6021



RAL 7032



RAL 7046

CARMEN

idea: *Pietro Lovato*



TECHNICAL INFORMATION

1. SCOCCA:

Struttura in multistrato di legno imbottito con spugna e rivestita

2. MECCANISMO:

Comando elevazione a gas, finitura nera

3. GAS:

- Regolabile in altezza, rotazione, finitura cromata
- Altezza fissa, ritorno automatico, finitura cromata

4. BASE:

- Base 4 razze in alluminio, Ø 630mm, finitura lucida
- Base 4 razze in ferro, Ø 720mm, finitura cromata (15µm)
- Base a disco in lastra d'acciaio, Ø480mm, finitura cromata (15µm)
- Base 4 gambe a ragno in tubo d'acciaio Ø 20mm, finitura cromata (15µm)
- Base 4 gambe in tubo d'acciaio Ø 16mm, finitura cromata (15µm)

1. SHELL :

Plywood structure, foam padding, upholstery

2. MECHANISM:

Height adjustable, Black finish

3. GAS LIFT:

- Height adjustable, swivel, chromed finish
- Not height adjustable, memory return cylinder, chromed finish

4. BASE:

- Polished aluminium 4 spoke base, Ø630 mm
- Iron 4 spoke base, Ø 720 mm chromed finish (15µm)
- Round base, Ø480mm steel plate, chromed finish (15µm)
- 4 legs swivel base, Ø 22 mm steel tube, chromed finish (15µm)
- 4 legs base, Ø16mm steel tube, chromed finish (15µm)

1. COQUE:

Structure en multiplie de bois rembourré de mousse et tapissée

2. MECANISME:

Réglable en hauteur, finition noir

3. VERIN A GAZ:

- Réglable en hauteur, pivotant, finition chromé
- Hauteur fixe, retour automatique, finition chromé

4. PIÈTEMENT:

- Piètement 4 branches alu poli, Ø 630mm
- Piètement 4 branches en métal, Ø 720mm, finition chromé (15µm)
- Piètement disque en acier Ø 480mm, finition chromé (15µm)
- Piètement araigné 4 pieds en tube d'acier Ø 20mm, finition chromé (15µm)
- Piètement 4 pieds en tube d'acier Ø 16mm, finition chromé (15µm)

1. SCHALE :

Holzstruktur, ausgepolstert mit Schwamm mit Bezug

2. MECHANIK :

Schwarze Sitzhöhenverstellung

3. GASFEDER :

- Sitzhöhenverstellung, drehbar, verchromt
- Ruckholmechanik ohne Sitzhöhenverstellung, verchromt

4. GESTELL :

- 4-Stern Alu poliertes Fußkreuz, Ø 630 mm
- 4-Stern Eisen Fußkreuz, Ø720mm verchromt (15µm)
- Stahlplatte Tellerfuß, Ø480mm, verchromt (15µm)
- 4-Fuß Drehkreuz, Ø20 mm Stahlrohr, verchromt (15µm)
- 4-Fuß Gestell, Ø16mm Stahlrohr, verchromt (15µm)

1. CASCO:

Estructura de madera multicapa acolchada con espuma y tapizada

2. MECANISMO:

Control de elevación de gas, acabado negro

3. GAS:

- Ajustable en altura, rotación, acabado cromado
- Altura fija, retorno automático, acabado cromado

4. BASE:

- Base de 4 radios en aluminio, Ø 630mm, acabado brillante
- Base de 4 estrellas en hierro, Ø 720 mm, acabado cromado (15µm)
- Base de disco en chapa de acero, Ø480mm, acabado cromado (15µm)
- Base 4 patas de araña en tubo de acero Ø 20 mm, acabado cromado (15µm)
- Base de 4 patas en tubo de acero Ø 16 mm, acabado cromado (15µm)



CARMEN



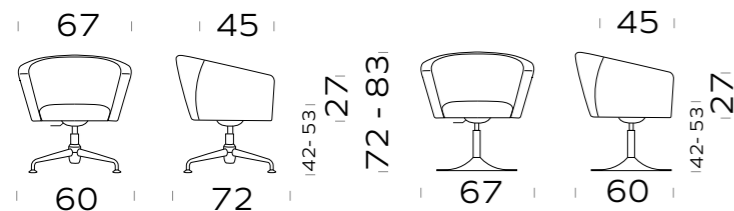





SCocca IN POLIURETANO, STRUTTURA IN METALLO, INTERAMENTE TAPPEZZATA
 POLYURETANE FOAM SHELL, METAL STRUCTURE, FULLY UPHOLSTERED
 COQUE EN POLYURÉTHANE, STRUCTURE EN MÉTAL, ENTIÈREMENT TAPISSEÉ
 POLYURETHAN SCHALE, METALLSTRUKTUR, AUSGEPOLSTERT
 CONCHA EN POLIURETANO, ESTRUCTURA EN METAL, COMPLETAMENTE TAPIZADA



Mechanism: **SeatPlate**↑

Regolazione altezza
 Height adjustment
 Réglage en hauteur
 Höhenverstellung
 Ajuste de altura



BASE BASE PIÈTEMENT GESTELL BASE	RUOTA/PIEDINO CASTOR/FEET ROULETTES/PATINS ROLLEN/GLEITER RUEDAS/PIES	STRUTTURA STRUCTURE STRUCTURE STRUKTUR ESTRUCTURA	CODICE CODE CODE ARTIKEL CÓDIGO	KG	TESSUTI/FINITURE UPHOLSTERIES/FINISHING REVÈTEMENTS STOFFGRUPPE TAPICERÍAS				
					D	E	F	G	H
 4 razze in ferro 4-spoke iron 4 branches en métal 4-Stern es Eisen Fußkreuz estrella en metal	 In tono Coordinated En teinte Je Farbton A juego	 Chromed	CN0002	12,30	988	1002	1072	1259	1389
		 RAL 9005 *	CN0019	12,30	932	946	1016	1203	1333
 base disco round base piètement disque en acier Stahlplate Tellerfuß base del disco	 feltrini felts feutres Filzgleiter fieltros	 Chromed	CN0004	13,90	893	909	977	1162	1293
		 RAL 9005 *	CN0020	13,90	810	826	894	1079	1210

* DISPONIBILE ANCHE IN
 ALSO AVAILABLE
 ÉGALEMENT DISPONIBLE EN
 ERHÄLTlich AUCH IN
 TAMBIÉN DISPONIBLE EN



RAL 9016



RAL 1012



RAL 3012



RAL 6021



RAL 7032

10







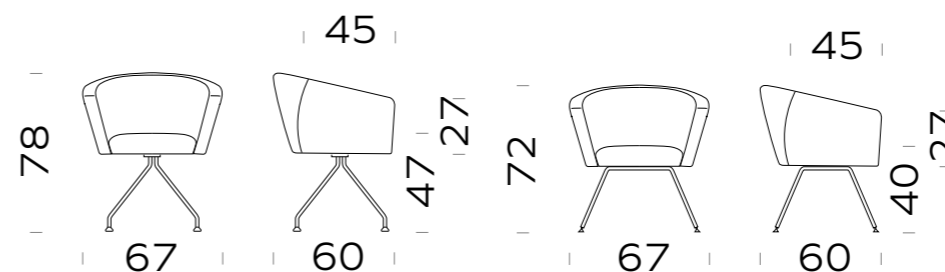

RAL 7046

CARMEN

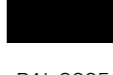
SCocca IN POLIURETANO, STRUTTURA IN METALLO, INTERAMENTE TAPPEZZATA
 POLYURETANE FOAM SHELL, METAL STRUCTURE, FULLY UPHOLSTERED
 COQUE EN POLYURÉTHANE, STRUCTURE EN MÉTAL, ENTIÈREMENT TAPISSEÉ
 POLYURETHAN SCHALE, METALLSTRUKTUR, AUSGEPOLSTERT
 CONCHA EN POLIURETANO, ESTRUCTURA EN METAL, COMPLETAMENTE TAPIZADA



BASE BASE PIÈTEMENT GESTELL BASE	RUOTA/PIEDINO CASTOR/FEET ROULETTES/PATINS ROLLEN/GLEITER RUEDAS/PIES	STRUTTURA STRUCTURE STRUCTURE STRUKTUR ESTRUCTURA	CODICE CODE CODE ARTIKEL CÓDIGO	KG	TESSUTI/FINITURE UPHOLSTERIES/FINISHING REVÈTEMENTS STOFFGRUPPE TAPICERÍAS				
					D	E	F	G	H
 ragno in ferro spider iron 4 pieds en métal 4-Fuß aus Eisen Araña en hierro	 tappi plugs patins Gleiter tapos	 Chromed	CN0010	10,80	752	764	834	1018	1151
		 RAL 9005 *	CN0012	10,80	724	736	806	990	1123
 4 gambe 4-legs 4 pieds 4-Fuß 4 patans	 piedini snodati leveler glides patins articulés Gelenkgleiter pies réglables	 Chromed	CN0011	10,70	741	758	824	1018	1153
		 RAL 9005 *	CN0017	10,70	726	743	809	1003	1138

* DISPONIBILE ANCHE IN
 ALSO AVAILABLE
 ÉGALEMENT DISPONIBLE EN
 ERHÄLTlich AUCH IN
 TAMBIÉN DISPONIBLE EN



RAL 9016



RAL 1012



RAL 3012



RAL 6021



RAL 7032

11



RAL 7046

HOOP
idea: *Pietro Lovato*



1. SCHIENALE:

Struttura in metallo, con imbottitura in poliuretano espanso ad alta densità schiumato a freddo, rivestita. Leggermente flessibile.

2. SEDUTA:

- Pouf Ø 40 cm base con struttura in metallo e polistirene espanso ad alta densità. Cuscino in poliuretano ad alta densità espanso a freddo, rivestito.
- Pouf Ø 60 cm base con struttura in metallo e polistirene espanso ad alta densità. Cuscino in poliuretano ad alta densità espanso a freddo, rivestito.

3. RUOTE/PIEDINI:

- Piedini regolabili neri antiribaltamento.
- Ruote autobloccanti Ø 50mm, gommate. Offrono la possibilità di spostare comodamente Hoop, diventano autobloccanti una volta che l'utente si siede.

1. BACKREST:

Metal frame with high density cold injected polyurethane foam, upholstered. Slightly flexible.

2. SEAT:

- Pouf Ø 40 cm Metal frame base with high density polystyrene foam, cushion in high density cold injected polyurethane foam, upholstered.
- Pouf Ø 60 cm Metal frame base with high density polystyrene foam, cushion in high density cold injected polyurethane foam, upholstered.

3. CASTOR/FEET:

- anti-tilt black adjustable glides.
- soft self-locking castors Ø 50mm. They allow to move comfortably HOOP, while they become self-locking once the user sits.

1. DOSSIER:

Châssis en métal, rembourré avec mousse polyuréthane haute densité moulé à froid, tapissé. Légèrement flexible.

2. ASSISE:

- Pouf Ø 40 cm Châssis en métal avec mousse polystyrène haute densité, assise en mousse polyuréthane haute densité moulé à froid, tapissé.
- Pouf Ø 60 cm Châssis en métal avec mousse polystyrène haute densité, assise en mousse polyuréthane haute densité moulé à froid, tapissé.

3. ROULETTES/PATINS:

- Patins réglables noirs anti-basculement.
- Roulettes gommées autobloquantes Ø 50mm. Elles permettent de déplacer confortablement HOOP, elles deviennent autobloquantes une fois que l'utilisateur s'assoit.

1. RÜCKENLEHNE:

Metalstruktur, mit kalt geschäumtem Polyurethan aus hohe Dichte geschäumt, mit Bezug. Leicht flexibel.

2. SITZPOUF:

- Pouf Ø 40 cm Metallbasis mit hochdichtem expandiertem Polystyrol Struktur, Kissen aus kalt geschäumtem Polyurethanschaum mit Bezug.
- Pouf Ø 60 cm Metallbasis mit hochdichtem expandiertem Polystyrol Struktur, Kissen aus kalt geschäumtem Polyurethanschaum mit Bezug.

3. ROLLEN/GLEITER:

- Verstellbare schwarze Kippschutzfüße.
- Weiche Stoprollen Ø 50. Sie bieten die Möglichkeit, den Hoop bequem zu verschieben und blockiert sobald der Benutzer sich draufsetzt.

1. RESPALDO:

Estructura en metal acolchada con espuma de poliuretano de alta densidad inyectada a frío, tapizada. Ligeramente flexible.

2. ASIENTO:

- Puf Ø 40 cm base con estructura en metal y poliuretano expandido de alta densidad cojín en poliuretano de alta densidad expandido a frío, tapizado.
- Puf Ø 60 cm base con estructura en metal y poliuretano expandido de alta densidad cojín en poliuretano de alta densidad expandido a frío, tapizado.

3. RUEDAS/PIES:

- Pies ajustables negras antivuelco.
- Ruedas autobloqueantes, Ø 50mm, blandas. Ofrecen la posibilidad de mover cómodamente HOOP, se bloquean cada vez que el usuario se sienta.



HOOP

SEDUTA POUF IN POLISTIRENE ESPANSO AD ALTA DENSITÀ CON STRUTTURA IN METALLO
 HIGH-DENSITY POLYSTYRENE OTTOMAN WITH METAL STRUCTURE
 POUF ROND EN POLYSTYRÈNE EXPANSÉ DE HAUTE DENSITÉ AVEC STRUCTURE EN MÉTAL
 SITZPOUF AUS EXPANDIERTES POLYSTYROL AUS HOHE DICHTHE, METALLSTRUKTUR
 PUF ASIENTO EN POLIESTIRENO EXPANDIDO DE ALTA DENSIDAD CON ESTRUCTURA EN METAL

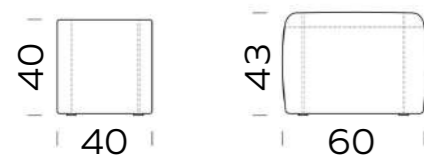



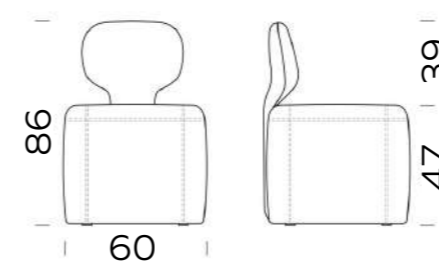

HOOP

SEDUTA POUF IN POLISTIRENE ESPANSO AD ALTA DENSITÀ CON STRUTTURA IN METALLO
 HIGH-DENSITY POLYSTYRENE OTTOMAN WITH METAL STRUCTURE
 POUF ROND EN POLYSTYRÈNE EXPANSÉ DE HAUTE DENSITÉ AVEC STRUCTURE EN MÉTAL
 SITZPOUF AUS EXPANDIERTES POLYSTYROL AUS HOHE DICHTHE, METALLSTRUKTUR
 PUF ASIENTO EN POLIESTIRENO EXPANDIDO DE ALTA DENSIDAD CON ESTRUCTURA EN METAL



BASE BASE PIETEMENT GESTELL BASE	RUOTA/PIEDINO CASTOR/FEET ROULETTES/PATINS ROLLEN/GLEITER RUEDAS/PIES	CODICE CODE ARTIKEL CÓDIGO	KG	TESSUTI/FINITURE UPHOLSTERIES/FINISHING REVETEMENTS STOFFGRUPPE TAPICERÍAS			
				D	E	F	G
 Ø 40 cm	 neri black noirs schwarze negro	XQ010	5,70	221	241	247	327
 Ø 60 cm	 neri black noirs schwarze negro	XQ015	11,20	390	417	432	536

BASE BASE PIETEMENT GESTELL BASE	RUOTA/PIEDINO CASTOR/FEET ROULETTES/PATINS ROLLEN/GLEITER RUEDAS/PIES	CODICE CODE ARTIKEL CÓDIGO	KG	TESSUTI/FINITURE UPHOLSTERIES/FINISHING REVETEMENTS STOFFGRUPPE TAPICERÍAS			
				D	E	F	G
 Ø 60 con schienale Ø 60 with backrest Ø 60 avec dossier Ø 60 mit Rückenlehne Ø 60 con respaldo	 neri black noirs schwarze negro	HO0001	20,60	804	819	864	1097
 Ø 60 con schienale Ø 60 with backrest Ø 60 avec dossier Ø 60 mit Rückenlehne Ø 60 con respaldo	 neri + d.50 mm autobloccanti gommate black + soft self-locking d.50mm noirs + d.50mm autobloquantes gommées schwarze + weiche Stoprollen D.50mm negro + diam.50 autobloqueantes blandas	HO0002	20,70	950	962	1007	1239

TOSCA

idea: *Pietro Lovato*



1. SCOCCA:

Monoscocca in spugna schiumata a freddo con struttura portante in tubo tondo d'acciaio, Ø 16mm, rivestita

2. BASE:

- Base 4 razze in alluminio, Ø 630mm, finitura lucida
- Base 4 razze in ferro, Ø 720mm, finitura cromata (15µm)
- Base a disco in lastra d'acciaio, Ø480mm, finitura cromata (15µm)
- Base 4 gambe in tubo d'acciaio Ø 16mm, finitura cromata (15µm)

3. PIEDINI:

- Piedini snodati in poliamide, finitura cromata (15µm), nera o bianca
- Piedini in polimero termoplastico, h. 25mm, finitura cromata (15µm)
- Piedini in polimero termoplastico, h. 40mm, finitura cromata (15µm)
- Feltrini

1. SHELL :

Cold injected foam padding monocoque, Ø 16mm steel tube structure, upholstery

2. BASE:

- Iron 4 spoke base, Ø 720 mm chromed finish (15µm)
- Round base, Ø480mm steel plate, chromed finish (15µm)
- Polished aluminium 4 spoke base, Ø630 mm
- 4 legs base, Ø16mm steel tube, chromed finish (15µm)

3. FEET:

- Leveler glides in polyamide, chromed finishes (15µm), black or white
- h.25mm Thermoplastic polymer gliders chromed finish (15µm)
- h.40mm Thermoplastic polymer gliders, chromed finish (15µm)
- Felts

1. COQUE:

Monocoque en mousse moulée à froids avec châssis en tube d'acier rond, Ø 16mm, tapissée

2. PIÈTEMENT:

- Piètement 4 branches alu poli, Ø 630mm
- Piètement 4 branches en métal, Ø 720mm, finition chromée (15µm)
- Piètement disque en acier Ø 480mm, finition chromée (15µm)
- Piètement 4 pieds en tube d'acier Ø 16mm, finition chromée (15µm)

3. PATINS:

- Patins articulés et polyamide, finition chromée (15µm), noir ou blanc
- Patins polymère thermoplastique, h.25mm, finition chromée (15µm)
- Patins polymère thermoplastique, h.40mm, finition chromée (15µm)
- Feutres

1. SCHALE :

Kaltgeschäumten Polyurethan, mit Bezug, Ø 16mm Stahlrohrschale

2. GESTELL :

- 4-Stern Alu poliertes Fußkreuz, Ø 630 mm
- 4-Stern Eisen Fußkreuz, Ø720mm verchromt (15µm)
- Stahlplatte Tellerfuß, Ø480mm, verchromt (15µm)
- 4-Fuß Gestell, Ø 16mm Stahlrohr, verchromt (15µm)

3. GLEITER :

- Gelenkgleiter aus Polyamid, verchromt (15µm), schwarz oder weiss
- Thermoplastische Polymergleiter, H.25mm, verchromt (15µm)
- Thermoplastische Polymergleiter, H.40mm, verchromt (15µm)
- Filzgleiter

1. CASCO:

Monocasco en espuma inyectado a frío con estructura de soporte en tubo de acero redondo, Ø 16 mm, tapizado

2. BASE:

- Base de 4 radios en aluminio, Ø 630mm, acabado brillante
- Base de 4 estrellas en hierro, Ø 720 mm, acabado cromado (15µm)
- Base de disco en chapa de acero, Ø480mm, acabado cromado (15µm)
- Base de 4 patas en tubo de acero Ø 16 mm, acabado cromado (15µm)

3. PIES:

- Pies articulados en poliamida, acabado cromado (15µm), blanco o negro
- Pies en polimero termoplástico, h. 25 mm, acabado cromado (15µm)
- Pies en polimero termoplástico, h. 40 mm, acabado cromado (15µm)
- Fieltrós



TOSCA



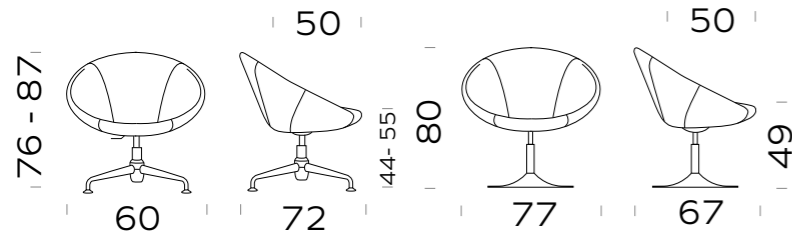

SCocca IN POLIURETANO, STRUTTURA IN METALLO, INTERAMENTE TAPPEZZATA
 POLYURETANE FOAM SHELL, METAL STRUCTURE, FULLY UPHOLSTERED
 COQUE EN POLYURÉTHANE, STRUCTURE EN MÉTAL, ENTIÈREMENT TAPISSEÉ
 POLYURETHAN SCHALE, METALLSTRUKTUR, AUSGEPOLSTERT
 CONCHA EN POLIURETANO, ESTRUCTURA EN METAL, COMPLETAMENTE TAPIZADA



Mechanism: **SeatPlate**↑↓

Regolazione altezza
 Height adjustment
 Réglage en hauteur
 Höhenverstellung
 Ajuste de altura



BASE BASE PIETEMENT GESTELL BASE	RUOTA/PIEDINO CASTOR/FEET ROULETTES/PATINS ROLLEN/GLEITER RUEDAS/PIES	STRUTTURA STRUCTURE STRUCTURE STRUKTUR ESTRUCTURA	CODICE CODE CODE ARTIKEL CÓDIGO	KG	TESSUTI/FINITURE UPHOLSTERIES/FINISHING REVETEMENTS STOFFGRUPPE TAPICERÍAS				
					D	E	F	G	H
 4 razze in ferro 4-spoke iron 4 branches en métal 4-Stern es Eisen Fußkreuz estrella en metal	 In tono Coordinated En teinte Je Farbton A juego	 Chromed	TC0002	12,70	830	842	972	1087	1251
		 RAL 9005 *	TC0017	12,70	774	786	916	1031	1195
 base disco round base piètement disque en acier Stahlplate Tellerfuß base del disco	 feltrini felts feutres Filzgleiter fietros	 Chromed	TC0004	14,40	847	863	901	1099	1281
		 RAL 9005 *	TC0018	14,40	764	780	818	1016	1198

* DISPONIBILE ANCHE IN
 ALSO AVAILABLE
 ÉGALEMENT DISPONIBLE EN
 ERHÄLTlich AUCH IN
 TAMBIÉN DISPONIBLE EN



RAL 9016



RAL 1012



RAL 3012



RAL 6021



RAL 7032





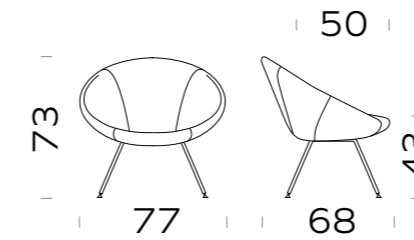

RAL 7046

TOSCA

SCocca IN POLIURETANO, STRUTTURA IN METALLO, INTERAMENTE TAPPEZZATA
 POLYURETANE FOAM SHELL, METAL STRUCTURE, FULLY UPHOLSTERED
 COQUE EN POLYURÉTHANE, STRUCTURE EN MÉTAL, ENTIÈREMENT TAPISSEÉ
 POLYURETHAN SCHALE, METALLSTRUKTUR, AUSGEPOLSTERT
 CONCHA EN POLIURETANO, ESTRUCTURA EN METAL, COMPLETAMENTE TAPIZADA



BASE BASE PIETEMENT GESTELL BASE	RUOTA/PIEDINO CASTOR/FEET ROULETTES/PATINS ROLLEN/GLEITER RUEDAS/PIES	STRUTTURA STRUCTURE STRUCTURE STRUKTUR ESTRUCTURA	CODICE CODE CODE ARTIKEL CÓDIGO	KG	TESSUTI/FINITURE UPHOLSTERIES/FINISHING REVETEMENTS STOFFGRUPPE TAPICERÍAS				
					D	E	F	G	H
 4 gambe 4-legs 4 pieds 4-Fuß Gestell 4 patas	 pedini snodati leveler glides patins articulés Gelenkgleiter pies réglables	 Chromed	TC0012	11,70	659	673	718	907	1089
		 RAL 9005 *	TC0016	11,70	644	658	703	892	1074

* DISPONIBILE ANCHE IN
 ALSO AVAILABLE
 ÉGALEMENT DISPONIBLE EN
 ERHÄLTlich AUCH IN
 TAMBIÉN DISPONIBLE EN



RAL 9016



RAL 1012



RAL 3012



RAL 6021



RAL 7032



RAL 7046

IRIS

idea: *Pietro Lovato*



1. SCOCCA:

Struttura in multistrato di legno imbottita in spugna, rivestita

2. BASE:

- Base a croce in alluminio, Ø 630mm, finitura lucida
- Base 4 gambe in tubo d'acciaio, Ø16mm, finitura cromata (15µm)
- Base 4 gambe in rovere

3. PIEDINI:

- Piedini snodati in poliamide, finitura cromata (15µm), nera o bianca
- Piedini in polimero termoplastico, h. 25mm, finitura cromata (15µm)
- Piedini in polimero termoplastico, h. 40mm, finitura cromata (15µm)
- Feltrini

1. SHELL:

Polywood shell padded upholstery foam, upholstery

2. BASE:

- Iron cross base, Ø 630 mm chromed finish (15µm)
- 4 legs base, Ø16mm steel tube chromed finish (15µm)
- 4 legs wooden base

3. FEET:

- Leveler glides in polyamide, chromed finishes (15µm), black or white
- H. 25mm Thermoplastic polymer gliders chromed finish (15µm)
- H. 40mm Thermoplastic polymer gliders, chromed finish (15µm)
- Felts

1. COQUE:

Monocoque en multiplie de bois et mousse revetue

2. PIÈTEMENT:

- Piètement 4 à croix alu poli, Ø 630mm
- Piètement 4 pieds en métal, Ø 16mm, finition chromé (15µm)
- Piètement 4 pieds en bois

3. PATINS:

- Patins articulés et polyamide, finition chromée (15µm), noir ou blanc
- Patins polymère thermoplastique, h.25mm, finition chromée (15µm)
- Patins polymère thermoplastique, h.40mm, finition chromée (15µm)
- Feutres

1. SCHALE:

Vollpolsterschale mit integrierten Armlehnen

2. GESTELL:

- Cross gestell Ø630 mm
- 4-Fuß gestell Ø16 mm verchromt (15µm)
- 4-Fuß gestell holzgestell

3. GLEITER:

- Gelenkgleiter aus Polyamid, verchromt (15µm), schwarz oder weiss
- Thermoplastische Polymergleiter, H.25mm, verchromt (15µm)
- Thermoplastische Polymergleiter, H.40mm, verchromt (15µm)
- Filzgleiter

1. CASCO:

Conca en madera multicapa acolchada en espuma y tapizada

2. GESTELL:

- Base a cruz de hierro, Ø 630 mm
- Base 4 patas cromo, Ø 16mm (15µm)
- Base 4 patas en madera

3. GLEITER:









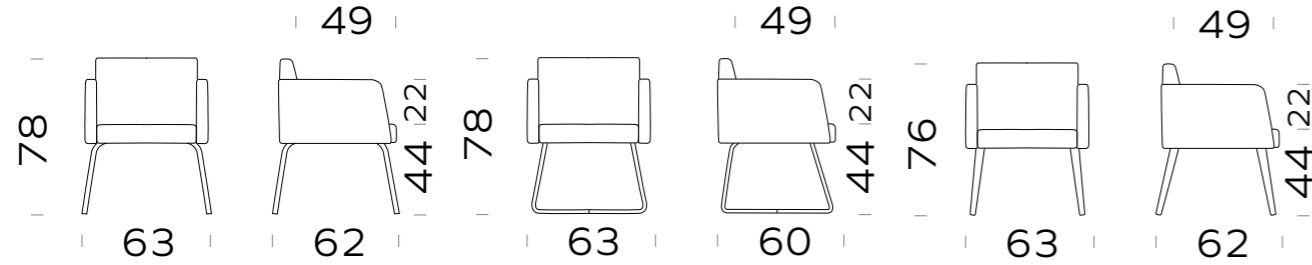



- Pies articulados en poliamida, acabado cromado (15µm), blanco o negro
- Pies en polimero termoplástico, h.25 mm, acabado cromado (15µm)
- Pies en polimero termoplástico, h.40 mm, acabado cromado (15µm)
- Fieltros



IRIS

STRUTTURA IN MULTISTRATO DI LEGNO, IMBOTTITA IN SPUGNA
 POLYWOOD MONOCOQUE PADDED UPHOLSTERY FOAM
 MONOCOQUE EN MULTIPLIE DE BOIS EN MOUSSE REVETUE
 VOLLPOLSTERSCHALE MIT INTEGRIERTEN ARMLEHNEN
 CONCHA EN MADERA MULTICAPA ACOLCHADA EN ESPUMA Y TAPIZADA



BASE BASE PIETEMET GESTELL BASE	RUOTA/PIEDINO CASTOR/FEET ROULETTES/PATINS ROLLEN/GLEITER RUEDAS/PIES	STRUTTURA STRUCTURE STRUCTURE STRUKTUR ESTRUCTURA	CODICE CODE CODE ARTIKEL CÓDIGO	KG	TESSUTI/FINITURE UPHOLSTERIES/FINISHING REVETEMENTS STOFFGRUPPE TAPICERIAS				
					D	E	F	G	H
 4 gambe in legno 4 legs wooden 4 pieds en bois 4-Fuß Holzgestell 4 patas en madera	 feltrini felts feutres Filzgleiter feltros	 BLEACHED LIGHT OAK 0001	IR0002	12,70	1168	1198	1228	1467	1884
		 WENGÉ 0003	IR0001	12,70	1168	1198	1228	1467	1884
 4 gambe 4-legs 4 pieds 4-Fuß 4 patans	 tappi plugs patins Gleiter tapos	 Chromed	IR0005	11,70	888	919	942	1136	1474
		 RAL 9005 *	IR0003	11,70	873	904	927	1121	1459
 base a croce cross base piet. à croix cross gestell base a cruz	 tappi plugs patins Gleiter tapos	 Chromed	IR0006	12,80	903	934	973	1156	1499
		 RAL 9005 *	IR0007	12,80	888	919	958	1141	1484

* DISPONIBILE ANCHE IN
 ALSO AVAILABLE
 ÉGALEMENT DISPONIBLE EN
 ERHÄLTlich AUCH IN
 TAMBIÉN DISPONIBLE EN



RAL 9016



RAL 1012



RAL 3012



RAL 6021



RAL 7032



RAL 7046

 MOVING

CUBIX

design: arch. Paolo Cocco



1. STRUTTURA:
Tubo d'acciaio Ø20 spessore 2, imbottito di poliuretano schiumato a freddo e con pannelli fonoisolanti, rivestito in tessuto

2. PANNELLO FONOSOLANTE:
Fibra riciclata in tessile tecnico di poliestere a densità crescente, sp. 25 mm

3. SCHIENALE:
Cuscino in spugna rivestita in tessuto

4. SEDILE:
Cuscino in spugna alto spessore (55 mm) rivestito in tessuto

5. BASE:
Trafilato d'acciaio 45x6, finitura cromata (15µm) o verniciata a polveri

6. TAVOLINO:
Pannello in tubo d'acciaio Ø20 spessore 2, imbottito di poliuretano schiumato a freddo, rivestito in tessuto

OPZIONALE: scatola elettrica con presa 2P+T 16A universale e alimentatore USB A+C 5V 3A

1. STRUCTURE:
Steel tube Ø20 thickness 2, padded with cold-foamed polyurethane and with soundproofing panels, fabric upholstery.

2. SOUND INSULATION PANEL:
Recycled fiber in increasing density polyester technical textile, th. 25 mm.

3. BACKREST:
Foam cushion, fabric upholstery.

4. SEAT:
High thickness foam cushion (55 mm), fabric upholstery.

5. BASE:
45x6 drawn steel, chromed finish (15µm) or powder coated.

6. TABLET:
Panel in steel tube Ø20 thickness 2, padded with cold-foamed polyurethane, fabric upholstery

OPTIONAL: electrical box with universal 2P + T 16A socket and USB A + C 5V 3A power supply

1. CHASSIS:
Tube en acier Ø20 épaisseur 2mm, rembourré de polyuréthane moulé à froid et avec panneaux insonorisants, revetu de tissu

2. PANNEAU D'ISOLATION ACOUSTIQUE:
Fibre recyclée en textile technique polyester de densité croissante, ép. 25 mm

3. DOSSIER:
Coussin en mousse revetu de tissu

4. ASSISE:
Coussin en mousse haute épaisseur (55 mm) revetu de tissu

5. PIETEMENT:
Acier étiré 45x6mm, finition chromée (15µm) ou verni époxy

6. TABLETTE:
Panneau en tube d'acier Ø20 épaisseur 2mm, rembourré de polyuréthane moulé à froid, revetu de tissu

EN OPTION : boîte électrique avec prise universelle 2P + T 16A et alimentation USB A + C 5V 3A

1. STRUKTUR:
Stahlrohr Ø20, Dicke 2mm, gepolstert mit kaltgeschäumtem Polyurethan, mit Schallschutzplatten und Stoffbezug

2. SCHALLISOLIERTE PLATTE:
Recycling-Faserplatte aus technischem Polyester mit steigender Dichte, 25mm dick

3. RÜCKENLEHNE:
Schaumstoffkissen mit Stoffbezug

4. SITZ:
Dickes Schaumstoffkissen (55mm) mit Stoffbezug

5. GESTELL:
Flachstahl 45x6mm, verchromt (15 µm) oder pulverbeschichtet

6. ABLAGETABLAR:
Stahlrohr Ø20, Dicke 2mm, gepolstert mit kaltgeschäumtem Polyurethan, mit Stoffbezug

OPTION: Universal Strom-Steckdose mit 2P + T 16A und USB-Anschluss A + C 5V 3A

1. ESTRUCTURA:
Tubo de acero Ø20 espesor 2, acolchado con poliuretano espumado en frío y con paneles insonorizantes, revestido de tejido

2. PANEL DE AISLAMIENTO ACÚSTICO:
Fibra reciclada en tejido técnico de poliéster de densidad creciente, es. 25 mm

3. RESPALDO:
Cojín de esponja cubierto de tejido

4. ASIENTO:
Cojín de esponja de alto espesor (55 mm) recubierto de tejido

5. BASE:
Acero estirado 45x6, acabado cromado (15µm) o pintado en polvo

6. MESA LATERAL DE APOYO:
Panel en tubo de acero Ø20 espesor 2, acolchado con poliuretano espumado en frío, revestido con tejido

OPCIONAL: caja eléctrica con toma universal 2P + T 16A y fuente de alimentación USB A + C 5V 3A



CONSEGNATO ASSEMBLATO, NON SERVONO ATTREZZI
DELIVERED ASSEMBLED, NO TOOLS NEEDED

LIVRÉ ASSEMBLÉ, AUCUN OUTIL REQUIS
ANGELIEFERT MONTIERT, BENÖTIGT KEINE WERKZEUGE





ENTREGADA ENSEMBLADA, NO REQUIERE HERRAMIENTAS

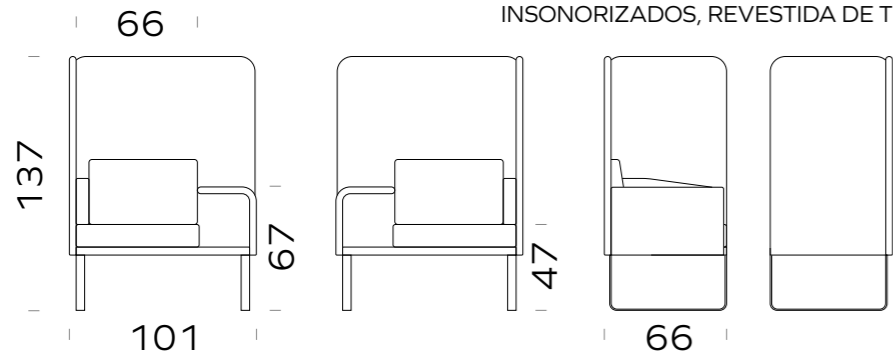

CUBIX

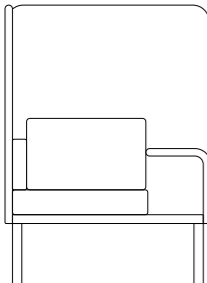
STRUTTURA IN ACCIAIO IMBOTTITA DI POLIURETANO E CON PANNELLI FONOISSOLANTI, RIVESTITA IN TESSUTO
 STEEL STRUCTURE PADDED WITH POLYURETHANE AND WITH SOUNDPROOFING PANELS, UPHOLSTERED IN FABRIC
 CHASSIS EN ACIER REMBOURRÉ DE POLYURÉTHANE ET AVEC PANNEAUX INSONORISANTS, REVÊTU DE TISSU
 STAHLSTRUKTUR MIT POLYURETHANSCHAUM, SCHALLISOLIERTE PLATTE, MIT STOFFBEZUG
 ESTRUCTURA DE ACERO ACOLCHADA CON POLIURETANO Y CON PANELES INSONORIZADOS, REVESTIDA DE TEJIDO



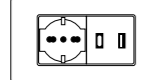

BASE BASE PIETEMENT GESTELL BASE	RUOTA/PIEDINO CASTOR/FEET ROULETTES/PATINS ROLLEN/GLEITER RUEDAS/PIES	STRUTTURA STRUCTURE STRUCTURE STRUKTUR ESTRUCTURA	CODICE CODE CODE ARTIKEL CÓDIGO	KG	TESSUTI/FINITURE * UPHOLSTERIES/FINISHING REVÊTEMENTS STOFFGRUPPE TAPICERÍAS		
					D	E	F
 base in metallo metal base pietement en acier stahlgestell base en metal	 feltrini felts feutres Filzgleiter fieltros	 Chromed	CU0001	27,50	1113	1192	1272
		 RAL 9005	CU0003	27,50	930	1009	1089
		 RAL 9016	CU0002	27,50	930	1009	1089

OPZIONE OPTIONALS OPTIONS OPTIONEN OPCIONES	VARIANTE VARIANT VARIANTE VARIANTE VARIANTE	CODICE CODE CODE ARTIKEL CÓDIGO	KG	PREZZO PRICE PRIX PREIS PRECIO
	Preso 2P+T 16A universale e alimentatore USB A+C 5V 3A <i>Universal 2P+T 16A socket and USB A+C 5V 3A power supply</i> Prise universelle 2P+T 16A et alimentation USB+A+C 5V 3A <i>Universal Strom-Steckdose mit 2P+T 16A und USB-Anschluss A+C 5V 3A</i> Toma universal 2P+T 16A y alimentación USB A+C 5V 3A	XA018	0,15	414

* Esclusa finta pelle e pelle
 Excluding imitation leather and leather
 Non disponible en cuir et simili cuir
 Ausgenommen Kunstleder und Leder
 Excluyendo cuero y ecocuero

CUBIX

COMPONENTS

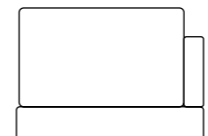
OPZIONE OPTIONALS OPTIONS OPTIONEN OPCIONES	VARIANTE VARIANT VARIANTE VARIANTE VARIANTE	CODICE CODE CODE ARTIKEL CÓDIGO	KG	TESSUTI/FINITURE UPHOLSTERIES/FINISHING REVÊTEMENTS STOFFGRUPPE TAPICERÍAS		
				D	E	F
1  DX	Tavolino Tablet Tablette Ablagetablar Mesa lateral de apoyo	XA015	7,00	245	263	281
1  SX	Tavolino Tablet Tablette Ablagetablar Mesa lateral de apoyo	XA019	7,00	245	263	281
2 	Pannello base Base panel Sous-assise Grundplatte Panle base	XA016	10,00	353	380	408
3 	Cuscini-spugna rivestita Cushions-upholstered sponge Coussins-mousse revetu Kissen-Schaumstoffkissen Cojines-esponja revestida	XA017	2,50	282	354	427

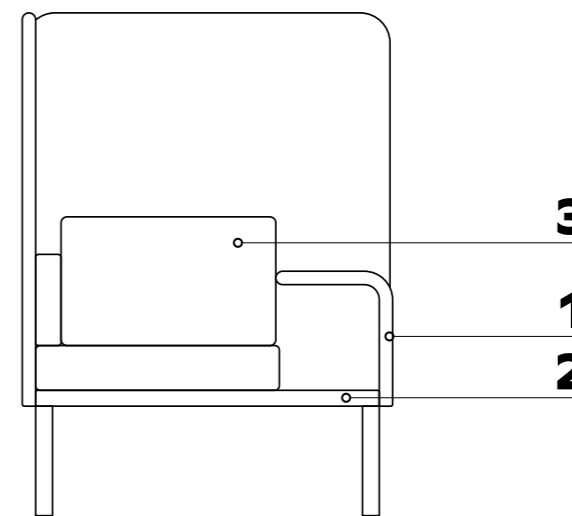

GIUNONE

idea: *Pietro Lovato*



TECHNICAL INFORMATION

1. STRUTTURA:
Struttura 1/2/3 posti in
multistrato di legno imbottito con
spugna e rivestita.
2. PIEDINI:
Piedino in alluminio o polimero
termoplastico, finitura cromata

1. STRUCTURE:
1/2/3 seats plywood structure,
foam padding, upholstery
2. FEET:
Aluminium or thermoplastic
polymer glides, chromed finish

1. STRUCTURE:
Structure 1/2/3 places en
multiplie de bois rembourré de
mousse et tapissée
2. PATINS:
Patin en aluminium ou polymère
thermoplastique, finition
chromée

1. STRUKTUR:
1/2/3 Sitz Holzstruktur
ausgepolstert mit Schwamm und
Gepolstert
2. GLEITER:
Aluminium oder Thermoplastik
Polymer Gleiter verchromt









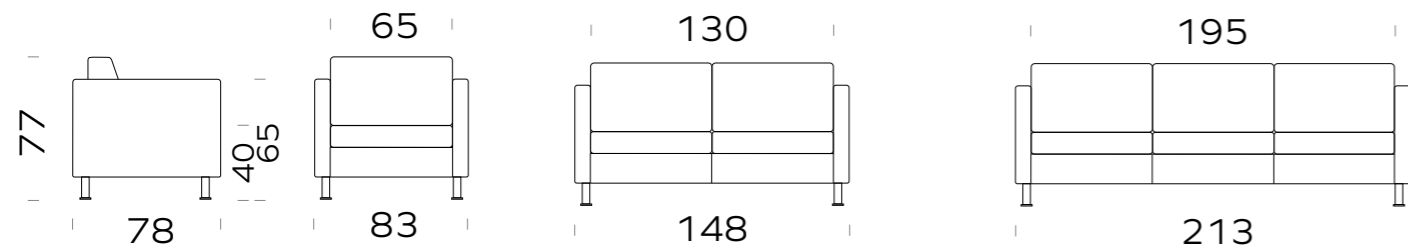

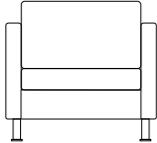

1. ESTRUCTURA:
Estructura 1/2/3 lugares en
madera multicapa recubierta
con espuma y tapizada
2. PIES:
Pie en aluminio o polimero
termoplástico, acabado
cromado

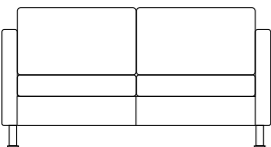

GIUNONE

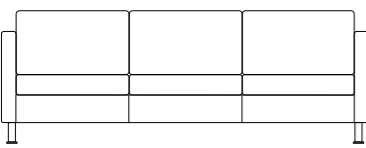
DIVANO IMBOTTITO, STRUTTURA IN LEGNO
 SOFA, UPHOLSTERED, WOODEN STRUCTURE
 CANAPE REMBOURRÉ, STRUCTURE EN BOIS
 SOFA, GEPOLSTERT, HOLZSTRUKTUR
 SOFA, TAPIZADO, CONCHA EN MADERA



BASE BASE PIETEMENT GESTELL BASE	RUOTA/PIEDINO CASTOR/FEET ROULETTES/PATINS ROLLEN/GLEITER RUEDAS/PIES	VARIANTE VARIANT VARIANTE VARIANTE VARIANTE	CODICE CODE CODE ARTIKEL CÓDIGO	KG	TESSUTI/FINITURE UPHOLSTERIES/FINISHING REVETEMENTS STOFFGRUPPE TAPICERÍAS			
					D	E	F	G
 1 posto 1 seat 1 place 1 Sitz 1 asiento	 piedini fissi fixed glides patins fixes Filzgleiter pies fijos	 Chromed Plastic	GI0002	26,30	1164	1219	1269	1612
		 Polished aluminium	GI0003	26,30	1277	1331	1378	1722
 2 posti 2 seats 2 places 2 Sitze 2 asientos	 piedini fissi fixed glides patins fixes Filzgleiter pies fijos	 Chromed Plastic	GI0005	34,50	1599	1675	1746	2242
		 Polished aluminium	GI0006	34,50	1711	1788	1855	2354
 3 posti 3 seats 3 places 3 Sitze 3 asientos	 piedini fissi fixed glides patins fixes Filzgleiter pies fijos	 Chromed Plastic	GI0008	46,00	1987	2088	2185	2887
		 Polished aluminium	GI0009	46,00	2094	2202	2299	2996

 MOVING

DAFNE

idea: *Pietro Lovato*



1. SCOCCA:

Scocca in poliuretano, struttura in metallo

2. BASE:

- Base girevole 5 razze in alluminio, Ø 670mm, finitura lucida
- Base piramidale in ferro, Ø 730mm, verniciata
- Base 4 gambe a ragno tubo in acciaio Ø 20, finitura cromata, verniciatura a polveri
- Base 4 gambe in rovere
- Base 4 gambe in ferro, finitura cromata (15 µm) o, verniciatura a polveri

3. RUOTE/PIEDINI:

- Ruote Ø 50mm, autofrenanti o autofrenanti e gommate finitura cromata
- Piedini in poliamide, h. 61mm, finitura cromata
- Feltrini

1. SHELL:

Polyurethane shell, metal structure

2. BASE:

- Swivel polished aluminium 5 spoke base, Ø 670 mm
- Pyramid iron base, Ø 730mm spoke powder coated
- 4 legs swivel base, Ø20 mm steel tube, chromed finish (15µm) or powder coated
- 4 legs wooden base
- 4 legs steel base chromed finish (15 µm) or powder coated

3. CASTORS/FEET:

- Ø 50 mm self-braking castors, or soft self-braking chromed finishing
- H. 61 mm polyamide glides chromed finishing
- Felts

1. COQUE:

Coque en polyurethane, structure en metal

2. PIETEMENT:

- Piètement pivotant 5 branches alu poli, Ø 670 mm
- Piètement pyramid en métal Ø 730 mm, verni époxy
- Piètement 4 pieds en métal, Ø 16mm, finition chromé (15µm), verni époxy
- Piètement 4 pieds en bois
- Piètement 4 pieds en hierro

3. ROULETTES/PATINS:

- Roulettes Ø 50mm, autofreinantes ou autofreinantes et gommées, finition chromé
- Patins en polyamide, h.61mm finition chromé
- Feutres

1. SCHALE:

Polyurethanschale, Metallgestell

2. GESTELL:

- Drehbar 5-Stern Alu poliertes Fußkreuz, Ø 670 mm
- Pyramid aus Eisen, Ø 730mm pulverbeschichtet
- 4-fuß aus Eisen Ø20 mm
- 4-fuß gestell holzgestell
- 4-fuß gestell aus Eisen

3. GLEITER:

- Ø 50 mm gebremste, oder weiche gebremste Rollen, verchromt
- Polyamidgleiter, H.61 mm verchromt
- Filzgleiter

1. CASCO:

Concha en poliuretano, estructura en metal

2. BASE:

- Base giratoria de 5 estrellas en aluminio, Ø 670 mm, acabado pulido
- Base piramidal en hierro
- Arana en hierro, Ø20mm
- Base 4 patas en madera
- Base 4 patas en hierro

3. RUEDAS/PIES:

- Ruedas crono goma diam. 50 autofreno acabado cromado
- Pies articulados en poliamida, acabado cromado h.61 mm
- Fieltros



DAFNE

SCocca IN POLIURETANO, STRUTTURA IN METALLO, INTERAMENTE TAPPEZZATA
 POLYURETANE FOAM SHELL, METAL STRUCTURE, FULLY UPHOLSTERED
 COQUE EN POLYURÉTHANE, STRUCTURE EN MÉTAL, ENTIÈREMENT TAPISSEÉ
 POLYURETHAN SCHALE, METALLSTRUKTUR, AUSGEPOLSTERT
 CONCHA EN POLIURETANO, ESTRUCTURA EN METAL, COMPLETAMENTE TAPIZADA

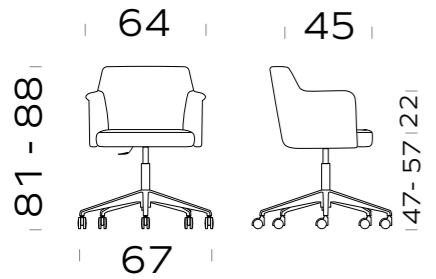

Mechanism: **SeatPlate**↑

Regolazione altezza
 Height adjustment
 Réglage en hauteur
 Höhenverstellung
 Ajuste de altura



BASE BASE PIETEMENT GESTELL BASE	RUOTA/PIEDINO CASTOR/FEET ROULETTES/PATINS ROLLEN/GLEITER RUEDAS/PIES	STRUTTURA STRUCTURE STRUCTURE STRUKTUR ESTRUCTURA	CODICE CODE CODE ARTIKEL CÓDIGO	KG	TESSUTI/FINITURE UPHOLSTERIES/FINISHING REVETEMENTS STOFFGRUPPE TAPICERÍAS				
					D	E	F	G	H
 5 razze in alluminio lucida 5-spoke polished aluminium 5 branches alu poli 5-Stern Alu poliertes Fußkreuz estrella en aluminio pulido	 d.50mm autofrenanti gommeate soft self-braking d.50mm d.50mm gommées autofreinante weiche gebremste D.50 mm ruedas goma diam.50 autofreno	 Polished	DF0002	10,30	682	706	726	876	1138

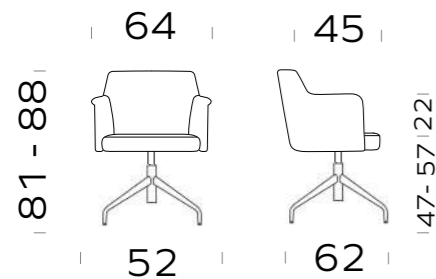

Mechanism: **Tilting Spring**

Blocco oscillante, Regolazione altezza
 (Un-)locking device, Height adjustment
 Système de blocage-débloccage de l'oscillation, Réglage en hauteur
 Blockierung der Rückenlehnen /Höhenverstellung
 Sistema de bloqueo-desbloqueo del respaldo, Ajuste de altura



BASE BASE PIETEMENT GESTELL BASE	RUOTA/PIEDINO CASTOR/FEET ROULETTES/PATINS ROLLEN/GLEITER RUEDAS/PIES	STRUTTURA STRUCTURE STRUCTURE STRUKTUR ESTRUCTURA	CODICE CODE CODE ARTIKEL CÓDIGO	KG	TESSUTI/FINITURE UPHOLSTERIES/FINISHING REVETEMENTS STOFFGRUPPE TAPICERÍAS				
					D	E	F	G	H
 piramidale in ferro pyramid iron pyramid en métal pyramid aus Eisen piramidal en hierro	 neri con feltrini black with felts noirs avec feutres schwarze Filzgleiter negros con fieltro	 RAL 9005	DF0030	15,50	870	894	914	1064	1326

* DISPONIBILE ANCHE IN
 ALSO AVAILABLE
 ÉGALEMENT DISPONIBLE EN
 ERHÄLTlich AUCH IN
 TAMBIÉN DISPONIBLE EN

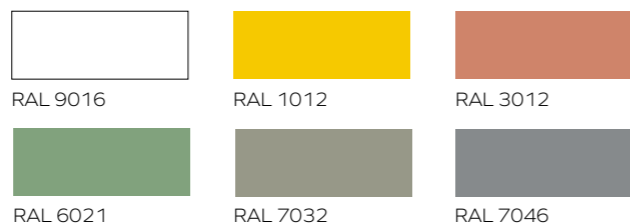

DAFNE

SCocca IN POLIURETANO, STRUTTURA IN METALLO, INTERAMENTE TAPPEZZATA
 POLYURETANE FOAM SHELL, METAL STRUCTURE, FULLY UPHOLSTERED
 COQUE EN POLYURÉTHANE, STRUCTURE EN MÉTAL, ENTIÈREMENT TAPISSEÉ
 POLYURETHAN SCHALE, METALLSTRUKTUR, AUSGEPOLSTERT
 CONCHA EN POLIURETANO, ESTRUCTURA EN METAL, COMPLETAMENTE TAPIZADA

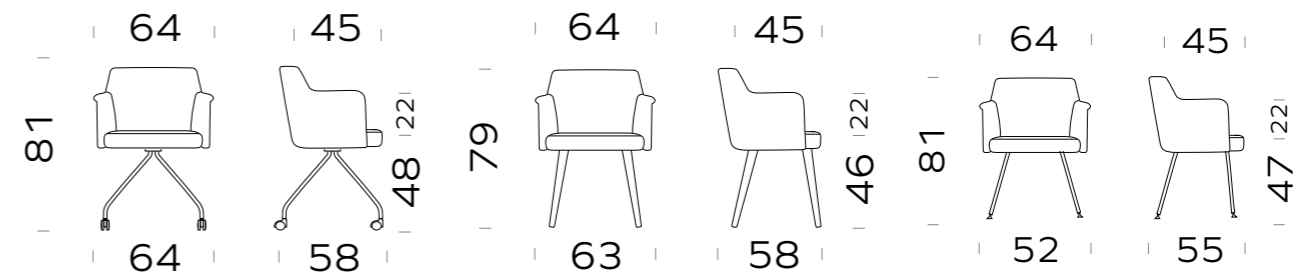

BASE BASE PIETEMENT GESTELL BASE	RUOTA/PIEDINO CASTOR/FEET ROULETTES/PATINS ROLLEN/GLEITER RUEDAS/PIES	STRUTTURA STRUCTURE STRUCTURE STRUKTUR ESTRUCTURA	CODICE CODE CODE ARTIKEL CÓDIGO	KG	TESSUTI/FINITURE UPHOLSTERIES/FINISHING REVETEMENTS STOFFGRUPPE TAPICERÍAS				
					D	E	F	G	H
 4 gambe in legno 4 legs wooden 4 pieds en bois 4-Fuß Holzgestell 4 patas en madera	 feltrini felts feutres Filzgleiter feltros	 BLEACHED LIGHT OAK 0001	DF0004	10,10	635	658	676	827	1090
		 WENGÉ 0003	DF0016	10,10	635	658	676	827	1090
 ragno in ferro spider iron 4 pieds en métal 4-Fuß aus Eisen Araña en hierro	 d.50mm autofrenanti gommeate soft self-braking d.50mm d.50mm gommées autofreinante weiche gebremste D.50 mm ruedas goma diam.50 autofreno	 Chromed	DF0014	10,20	710	734	752	904	1165
		 RAL 9005	DF0024	10,20	682	706	724	876	1137
 4 gambe 4-legs 4 pieds 4-Fuß Gestell 4 patas	 piedini snodati level glides patins articulés Gelenkgleiter pies réglables	 Chromed	DF0031	11,30	580	604	622	774	1035
		 RAL 9005	DF0032	11,30	565	589	607	759	1020

* DISPONIBILE ANCHE IN
 ALSO AVAILABLE
 ÉGALEMENT DISPONIBLE EN
 ERHÄLTlich AUCH IN
 TAMBIÉN DISPONIBLE EN



* DISPONIBILE ANCHE CON
 ALSO AVAILABLE WITH
 ÉGALEMENT DISPONIBLE AVEC
 ERHÄLTlich AUCH MIT
 TAMBIÉN DISPONIBLE CON



SAME PRICE

OPZIONE OPTIONALS OPTIONS OPTIONEN OPCIONES	VARIANTE VARIANT VARIANTE VARIANTE VARIANTE	CODICE CODE CODE ARTIKEL CÓDIGO	KG	PREZZO PRICE PRIX PREIS PRECIO
J	Tavolino scrittoio girevole <i>Wide swivel writing tablet</i> Tablette pivotante grande <i>Drehbare Schreibtafel</i> Pala giratoria escritorio ONLY FOR DF0002	XS009	1,30	281

SLIM Fixed

idea: *Pietro Lovato*



1. SCOCCA:

Monoscocca in tecnopolimero, finitura RAL o imbottita con spugna e rivestita, con struttura di sostegno in tubo tondo d'acciaio, Ø16mm, con o senza braccioli, finitura cromata (15µm) o verniciata a polveri

2. BASE:

- Base 4 gambe in tubo d'acciaio Ø 16mm, con o senza braccioli, finitura cromata (15µm) o verniciata a polveri
- Base a slitta in tubo d'acciaio Ø 16mm, con o senza braccioli, finitura cromata (15µm) o verniciata a polveri
- Base mensa in tubo d'acciaio Ø 20mm, finitura cromata (15µm) o verniciata a polveri

3. PIEDINI:

- Piedini snodati in poliamide, finitura cromata (15µm), nera o bianca
- Tappi in polipropilene, finitura nera o bianca
- Tappi antiribaltamento in poliamide, finitura nera

1. SHELL:

Engineering polymer monocoque, ral finish or foam padded and upholstered. Round steel bar structure Ø16mm, with or without armrests, chromed finish (15µm) or powder coated

2. BASE:

- 4 legs base, Ø 16 mm steel tube, with or without armrest, chromed finish (15µm) or powder coated
- Cantilever base, Ø 16 mm steel tube, with or without armrest, chromed finish (15µm) or powder coated
- Reverse cantilever base Ø 20mm steel tube, chromed finish (15µm) or powder coated

3. FEET:

- Leveler glides in polyamide, chromed finishes (15µm), black or white
- polypropylene plugs, black or white finish
- polyamide anti overturning plugs, black finish

1. COQUE:

Monocoque en polymère technique, finition RAL ou rembourrée de mousse et tapissée. Structure de support en tube d'acier, Ø16mm, avec ou sans accoudoirs, finition chromé (15µm) o verni époxy

2. PIÈTEMENT:

- Piètement 4 pieds en tube d'acier Ø 16mm, avec ou sans accoudoirs, finition chromé (15µm) ou verni époxy
- Piètement luge en tube d'acier Ø 16mm, avec ou sans accoudoirs, finition chromé (15µm) ou verni époxy
- Piètement luge inversé en tube d'acier Ø 20mm, finition chromé (15µm) o verni époxy

3. PATINS:

- Patins articulés et polyamide, finition chromée (15µm), noir ou blanc
- Tampons en polypropylène, finition noir ou blanc
- Tampons anti renversement en polyamide, finition noir

1. SCHALE:

Technopolymer Schale, RAL Farben oder ausgepolstert mit Schwamm und Stoffbezug, Rund-Stahlrohrgestell Ø 16 mm, mit oder ohne Armlehnen, verchromt (15µm) oder pulverbeschichtet

2. GESTELL :

- 4-Fuß Gestell, Ø 16mm Stahlrohr, mit oder ohne Arm. verchromt (15µm) oder pulverbeschichtet
- Kufengestell, Ø 16mm Stahlrohr, mit oder ohne Arm. verchromt (15µm) oder pulverbeschichtet
- C-Gestell, Ø20mm Stahlrohr, verchromt (15µm) oder pulverbeschichte

3. GLEITER :

- Gelenkgleiter aus Polyamid, verchromt (15µm), schwarz oder weiss
- Polyamid gleiter, schwarze oder weisse
- Schwarze Polyamid Antirollgleiter

1. CASCO:

Monocasco de tecnopolímero, acabado RAL o acolchado con espuma y recubierto en tejido, con estructura de soporte en tubo de acero redondo, Ø16mm, con o sin brazos, acabado cromado (15µm) o con recubrimiento en polvo

2. BASE:

- Base de 4 patas en tubo de acero Ø 16 mm, con o sin reposabrazos, acabado cromado (15µm) o con recubrimiento en polvo
- Base de trineo en tubo de acero de Ø 16 mm, con o sin reposabrazos, acabado cromado (15µm) o con recubrimiento en polvo
- Base de ataúd en tubo de acero de Ø 20 mm, acabado cromado (15µm) o con recubrimiento en polvo

3. PIES:

- Pies articulados en poliamida, acabado cromado (15µm), blanco o negro
- Tapones de polipropileno, acabado negro o blanco.
- Tapones antivuelco en poliamida, acabado negro.

TECHNICAL INFORMATION









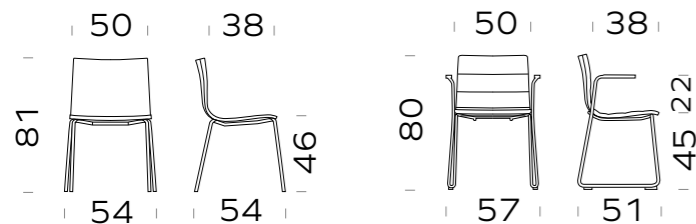

ID 1111209613



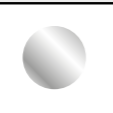

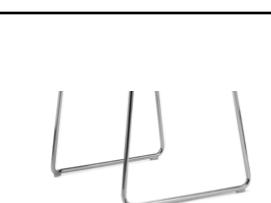
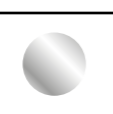





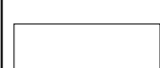





SLIM Fixed

SCocca IN TECNopolIMERO, STRUTtura IN METalLO
ENGINEERING POLIMER SHELL, METAL STRUCTURE
COQUE EN POLYMERÉ TECHNIQUE, STRUCTURE EN MÉTAL
TECHNOPOLYMER SCHALE, METALSTRUKTUR
CONCHA EN TECNOLÍMERO, ESTRUCTURA EN METAL



10

BASE BASE PIETEMENT GESTELL BASE	RUOTA/PIEDINO CASTOR/FEET ROULETTES/PATINS ROLLEN/GLEITER RUEDAS/PIES	STRUTTURA STRUCTURE STRUCTURE STRUKTUR ESTRUCTURA	VARIANTE VARIANT VARIANTE VARIANTE VARIANTE	CODICE CODE CODE ARTIKEL CÓDIGO	KG	PREZZO PRICE PRIX PREIS PRECIO		
						SHELL RAL		
 4 gambe 4-legs 4 pieds 4-Fuß 4 patans	 tappi plugs patins Gleiter tapos	 Chromed	con braccioli with arms avec accoudories mit Armlehnen con brazos	SL0018	5,50	196		
			senza braccioli without arms sans accoudories ohne Armlehnen sin brazos	SL0020	4,80	167		
		 RAL 9005 *	 slitta sled luge Kufengestell patin	 Chromed	con braccioli with arms avec accoudories mit Armlehnen con brazos	SL0001	5,50	186
					senza braccioli without arms sans accoudories ohne Armlehnen sin brazos	SL0007	4,80	162
					con braccioli with arms avec accoudories mit Armlehnen con brazos	SL0029	6,20	225
					senza braccioli without arms sans accoudories ohne Armlehnen sin brazos	SL0025	5,40	196
 RAL 9005 *	 tappi plugs patins Gleiter tapos	 RAL 9005 *	con braccioli with arms avec accoudories mit Armlehnen con brazos	SL0027	6,20	219		
			senza braccioli without arms sans accoudories ohne Armlehnen sin brazos	SL0023	5,40	190		

*STRUCTURE RAL	SHELL RAL
DISPONIBILE ANCHE IN ALSO AVAILABLE ÉGALEMENT DISPONIBLE EN ERHÄLTlich AUCH IN TAMBIÉN DISPONIBLE EN  RAL 9016  RAL 1012  RAL 3012  RAL 6021  RAL 7032  RAL 7046	 RAL 9016  RAL 1012  RAL 3012  RAL 3001  RAL 6021  RAL 7032  RAL 5009  RAL 7046  RAL 9005  RAL 9016

* DISPONIBILE ANCHE CON
ALSO AVAILABLE WITH
ÉGALEMENT DISPONIBLE AVEC
ERHÄLTlich AUCH MIT
TAMBIÉN DISPONIBLE CON





 piedini snodati
leveler glides
patins articulés
Gelenkgleiter
pies regulables



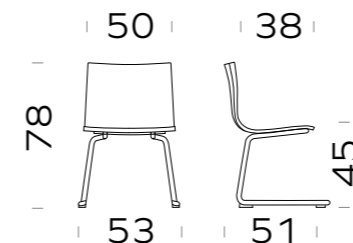



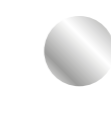









+15€

SLIM Fixed

SCocca IN TECNopolIMERO, STRUTtura IN METalLO
ENGINEERING POLIMER SHELL, METAL STRUCTURE
COQUE EN POLYMERÉ TECHNIQUE, STRUCTURE EN MÉTAL
TECHNOPOLYMER SCHALE, METALSTRUKTUR
CONCHA EN TECNOLÍMERO, ESTRUCTURA EN METAL



BASE BASE PIETEMENT GESTELL BASE	RUOTA/PIEDINO CASTOR/FEET ROULETTES/PATINS ROLLEN/GLEITER RUEDAS/PIES	STRUTTURA STRUCTURE STRUCTURE STRUKTUR ESTRUCTURA	CODICE CODE CODE ARTIKEL CÓDIGO	KG	PREZZO PRICE PRIX PREIS PRECIO
					SHELL RAL
 base mensa reverse cantilever base piétement appui sur table C-Gestell base patin revers	 neri con feltrini black with felts noirs avec feutres schwarze Filzgleiter negro con fieltro	 Chromed	SL0040	6,10	203
			 RAL 9005 *	SL0036	6,10

*STRUCTURE RAL	SHELL RAL
DISPONIBILE ANCHE IN ALSO AVAILABLE ÉGALEMENT DISPONIBLE EN ERHÄLTlich AUCH IN TAMBIÉN DISPONIBLE EN  RAL 9016  RAL 1012  RAL 3012  RAL 6021  RAL 7032  RAL 7046	 RAL 9016  RAL 1012  RAL 3012  RAL 3001  RAL 6021  RAL 7032  RAL 5009  RAL 7046  RAL 9005  RAL 9016

SLIM Stool

idea: *Pietro Lovato*



TECHNICAL INFORMATION

1. SCOCCA:

Monoscocca in tecnopolimero, finitura RAL o imbottita con spugna e rivestita, con struttura di sostegno in tubo tondo d'acciaio, Ø16mm, con o senza braccioli, finitura cromata (15µm) o verniciata a polveri

2. BASE:

- Base 4 gambe sgabello in tubo d'acciaio Ø 16mm, finitura cromata (15µm) o verniciata a polveri
- Base a slitta sgabello in tubo d'acciaio Ø 16mm, finitura cromata (15µm) o verniciata a polveri

3. PIEDINI:

Tappi in polipropilene, fin. nera o bianca

1. SHELL:

Engineering polymer monocoque, ral finish or foam padded and upholstered. Round steel bar structure Ø 16mm, with or without armrests, chromed finish (15µm) or powder coated

2. BASE:

- 4 legs stool base, Ø 16 mm steel tube, chromed finish (15µm) or powder coated
- Cantilever stool base, Ø 16 mm steel tube, chromed finish (15µm) or powder coated

3. FEET:

Polypropylene plugs, black or white finish

1. COQUE:

Monocoque en polymère technique, finition RAL ou rembourrée de mousse et tapissée. Structure de support en tube d'acier, Ø16mm, avec ou sans accoudoirs, finition chromé (15µm) o verni époxy

2. PIÈTEMENT:

- Piètement 4 pieds tabouret en tube d'acier Ø 16mm, finition chromé (15µm) ou verni époxy
- Piètement luge tabouret en tube d'acier Ø 16mm, finition chromé (15µm) ou verni époxy

3. PATINS:

Tampons en polypropylène, finition noir ou blanc

1. SCHALE:

Technopolymer Schale, RAL Farben oder ausgepolstert mit Schaumstoff und Bezug, Rund-Stahlrohrgestell Ø 16 mm, mit oder ohne Armlehnen, verchromt (15 µm) oder pulverbeschichtet

2. GESTELL :

- 4-Fuß Hocker Gestell, Ø 16mm Stahlrohr, mit oder ohne Armle, verchromt (15µm) oder pulverbeschichtet
- Hocker Kufengestell, Ø 16mm Stahlrohr verchromt (15µm) oder pulverbeschichtet

3. GLEITER :

Polyamid gleiter, schwarze oder weisse

1. CASCO:

Monocasco en tecnopolimero, acabado RAL o acolchado con espuma y forrado, con estructura de soporte en tubo de acero redondo, Ø16mm, con o sin brazos, acabado en cromo (15 µm) o con recubrimiento en polvo

2. BASE:

Base de 4 patas de heces en tubo de acero de Ø 16 mm, acabado cromado (15 µm) o con recubrimiento de polvo

3. PIES:

Tapones de polipropileno, aleta. negro o blanco









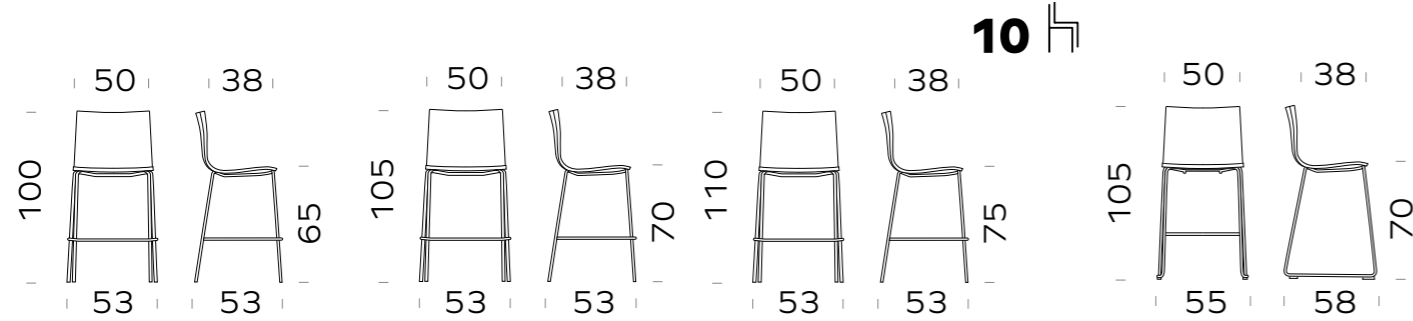

ID 1111209613















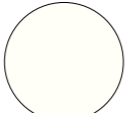

SLIM Stool

SCOCCA IN TECNOPOLIMERO, STRUTTURA IN METALLO
 ENGINEERING POLIMER SHELL, METAL STRUCTURE
 COQUE EN POLYMÈRE TECHNIQUE, STRUCTURE EN MÉTAL
 TECNOPOLYMER SCHALE, METALSTRUKTUR
 CONCHA EN TECNOPOLÍMERO, ESTRUCTURA EN METAL

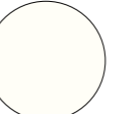

BASE BASE PIETEMENT GESTELL BASE	RUOTA/PIEDINO CASTOR/FEET ROULETTES/PATINS ROLLEN/GLEITER RUEDAS/PIES	STRUTTURA STRUCTURE STRUCTURE STRUKTUR ESTRUCTURA	ALTEZZA HEIGHT HAUTEUR HOHE ALTURA	CODICE CODE CODE ARTIKEL CÓDIGO	KG	PREZZO PRICE PRIX PREIS PRECIO
						SHELL RAL
 <p>4 gambe sgabello 4-legs stool 4 pieds tabouret 4-Fuß Hocker 4 patans taburete</p>	 <p>tappi plugs patins Gleiter tapos</p>	 <p>Chromed</p>	65 cm	SL0430	6,70	232
			70 cm	SL0022		
			75 cm	SL0424		
		 <p>RAL 9005 *</p>	65 cm	SL0411	6,70	222
			70 cm	SL0013		
			75 cm	SL0410		
 <p>slitta sgabello sled stool luge tabouret Hocker Kufengestell patin taburete</p>	 <p>tappi plugs patins Gleiter tapos</p>	 <p>Chromed</p>	70 cm	SL0033	6,60	266
			 <p>RAL 9005 *</p>	70 cm	SL0031	6,60

 MOVING

*STRUCTURE RAL	SHELL RAL
<p>DISPONIBILE ANCHE IN ALSO AVAILABLE ÉGALEMENT DISPONIBLE EN ERHÄLTlich AUCh IN TAMBIÉN DISPONIBLe EN</p>  <p>RAL 9016</p>  <p>RAL 1012</p>  <p>RAL 3012</p>  <p>RAL 6021</p>  <p>RAL 7032</p>  <p>RAL 7046</p>	 <p>RAL 9016</p>  <p>RAL 1012</p>  <p>RAL 3012</p>  <p>RAL 3001</p>  <p>RAL 6021</p>  <p>RAL 7032</p>  <p>RAL 5009</p>  <p>RAL 7046</p>  <p>RAL 9005</p>  <p>RAL 9016 </p>

SLIM Swivel

idea: *Pietro Lovato*



1. STRUTTURA:

Monoscocca in tecnopolimero, finitura RAL o imbottita con spugna e rivestita, con struttura di sostegno in tubo tondo d'acciaio, Ø16mm, con o senza braccioli, finitura cromata (15µm) o verniciata a polveri

2. BASE:

Base 4 gambe a ragno in tubo d'acciaio Ø 20mm, finitura cromata (15µm) o verniciata a polveri

3. RUOTE/PIEDINI:

- Ruote Ø 50mm, autofrenanti o autofrenanti e gommate, finitura cromata o nera
- Piedini in polimero termoplastico, h. 68mm, finitura cromata (15µm) o nera

4. BRACCIOLI:

- Bracciolo triangolare in tondo d'acciaio, Ø 12mm, finitura cromata (15µm) o verniciata a polveri (imbottito e rivestito)
- Bracciolo fisso in tubo tondo d'acciaio, Ø 16mm, finitura cromata (15µm) o verniciata a polveri, con top in poliammide, finitura nera

1. STRUCTURE:

Engineering polymer monocoque, ral finish or foam padded and upholstered. Round steel bar structure Ø16mm, with or without armrests, chromed finish (15µm) or powder coated

2. BASE:

4 legs swivel base, Ø 22 mm steel tube, chromed finish (15µm) or powder coated

3. CASTORS/FEET:

- Ø 50 mm self-braking castors, or soft self-braking. Black or Chromed finish
- h. 68 mm Thermoplastic polymer gliders chromed (15µm) or black finish

4. ARMREST:

- Steel round bar Ø12 mm, triangular armrest, chromed finish (15µm) or powder coated. Padded and upholstered
- Fixed armrest, round steel tube, Ø16mm, chromed finish (15µm), or powder coated, polyamide top pad, black finish

1. STRUCTURE:

Monocoque en polymère technique, finition RAL ou rembourrée de mousse et tapissée. Structure de support en tube d'acier, Ø16mm, avec ou sans accoudoirs, finition chromé (15µm) ou verni époxy

2. PIÈTEMENT:

Piètement araigné 4 pieds en tube d'acier Ø 20mm, finition chromé (15µm) ou verni époxy

3. ROULETTES/PATINS:

- Roulettes Ø 50mm, autofreinantes ou autofreinantes et gommées, finition chromé ou noir
- Patins en polymère thermoplastique, h.68mm, finition chromée (15µm) ou noir

4. ACCOUDOIR:

- Accoudoir triangulaire en tige d'acier, Ø 12mm, finition chromé (15µm) ou verni époxy (manchette rembourrée et tapissée)
- Accoudoir fixe en tube rond d'acier, Ø 16mm, finition chromée (15µm) ou verni époxy, manchette en polyamide, finition noir

1. STRUKTUR:

Technopolymer Schale, RAL Farben oder ausgepolstert mit Schwamm und Bezug, Rund-Stahlrohrgestell Ø 16 mm, mit oder ohne Armlehnen, verchromt (15 µm) oder pulverbeschichtet

2. GESTELL:

4-Fuß Drehkreuz, Ø20 mm Stahlrohr, verchromt (15µm) oder pulverbeschichtet

3. ROLLEN/GLEITER:

- Ø 50 mm gebremste, oder weiche gebremste Rollen, schwarz oder verchromt
- Thermoplastische Polymergleiter, H.68 mm verchromt (15 µm) oder schwarz

4. ARMLEHNE:

- Feste dreieckige Armlehne aus Stahlstab, Ø 12 mm, verchromt (15 µm) oder pulverbeschichtet, ausgepolstert mit Bezug
- Feste Armlehne aus Stahlrohr, Ø 16 mm, verchromt (15 µm) oder pulverbeschichtet, schwarze Polyamid Armauflage

1. ESTRUCTURA:

Monocasco en termopolimero, acabado RAL o acolchado con espuma y forrado, con estructura de soporte en tubo de acero redondo, Ø16mm, con o sin brazos, acabado en cromo (15 µm) o con recubrimiento en polvo

2. BASE:

Base 4 patas de araña en tubo de acero de Ø 20 mm, acabado cromado (15 µm) o con recubrimiento en polvo

3. RUEDAS / PIES:

- Ruedas de Ø 50 mm, autofrenado o autofrenado y blandas, acabado negro o cromo
- Pies en polímero termoplástico, h. 68 mm, acabado cromado (15µm) o negro

4. BRAZOS:

- Reposabrazos triangulares de acero redondo, Ø 12 mm, acabado cromado (15 µm) o con recubrimiento en polvo (acolchado y tapizado)
- Reposabrazos fijos en tubo de acero redondo, Ø 16 mm, acabado cromado (15 µm) o con recubrimiento en polvo, con top de poliamida, acabado negro





ID 1111209613



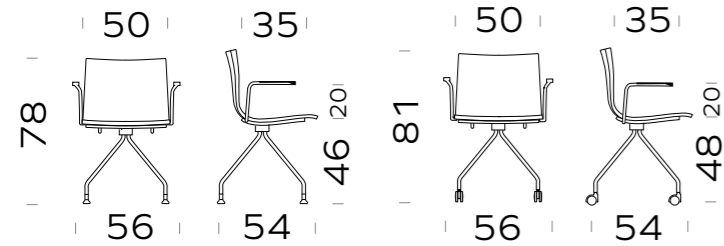











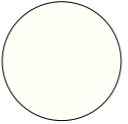

SLIM Swivel

SCocca IN TECNOPOLIMERO, STRUTTURA IN METALLO
 ENGINEERING POLIMER SHELL, METAL STRUCTURE
 COQUE EN POLYMÈRE TECHNIQUE, STRUCTURE EN MÉTAL
 TECHNOLYMER SCHALE, METALSTRUKTUR
 CONCHA EN TECNOLÍMERO, ESTRUCTURA EN METAL



BASE BASE PIETEMENT GESTELL BASE	RUOTA/PIEDINO CASTOR/FEET ROULETTES/PATINS ROLLEN/GLEITER RUEDAS/PIES	STRUTTURA STRUCTURE STRUCTURE STRUKTUR ESTRUCTURA	VARIANTE VARIANT VARIANTE VARIANTE VARIANTE	CODICE CODE CODE ARTIKEL CÓDIGO	KG	PREZZO PRICE PRIX PREIS PRECIO
						SHELL RAL
 ragno in ferro spider iron 4 pieds en métal 4-Fuß aus Eisen Araña en hierro	 d.50mm autofrenanti gommate soft self-braking d.50mm d.50mm gommées autofrein. weiche gebremste D.50 mm ruedas goma diam.50 autofreno	 Chromed	con braccioli with arms avec accoudories mit Armlehnen con brazos	SL0086	8,80	343
			senza braccioli without arms sans accoudories ohne Armlehnen sin brazos	SL0057	7,70	311
		 RAL 9005 *	con braccioli with arms avec accoudories mit Armlehnen con brazos	SL0096	8,60	315
			senza braccioli without arms sans accoudories ohne Armlehnen sin brazos	SL0067	7,50	283

 MOVING

* STRUCTURE RAL	SHELL RAL
DISPONIBILE ANCHE IN ALSO AVAILABLE ÉGALEMENT DISPONIBLE EN ERHÄLTlich AUCH IN TAMBIÉN DISPONIBLE EN  RAL 9016  RAL 1012  RAL 3012  RAL 6021  RAL 7032  RAL 7046	 RAL 9016  RAL 1012  RAL 3012  RAL 3001  RAL 6021  RAL 7032  RAL 5009  RAL 7046  RAL 9005  RAL 9016

* DISPONIBILE ANCHE CON
 ALSO AVAILABLE WITH
 ÉGALEMENT DISPONIBLE AVEC
 ERHÄLTlich AUCH MIT
 TAMBIÉN DISPONIBLE CON

 In tono
 Coordinated
 En teinte
 Je Farbton
 A juego

SAME PRICE

SLIM Task

idea: *Pietro Lovato*



TECHNICAL INFORMATION

1. STRUTTURA:

Monoscocca in tecnopolimero, finitura RAL o imbottita con spugna e rivestita, con struttura di sostegno in tubo tondo d'acciaio, Ø16mm, con o senza braccioli, finitura cromata (15µm) o verniciata a polveri

2. MECCANISMO:

Comando elevazione a gas, finitura nera

3. BASE:

- Base 5 razze in alluminio, Ø 670mm, finitura lucida
- Base 5 razze in poliamide con carica di fibra di vetro, Ø640mm, finitura nero

4. RUOTE/PIEDINI:

- Ruote Ø 50mm, autofrenanti o autofrenanti e gommate, finitura nera
- Piedini in poliamide, h. 61mm, finitura nera

5. BRACCIOLI:

Bracciolo triangolare in tondo d'acciaio, Ø 12mm, finitura cromata (15µm) o verniciata a polveri (imbottito e rivestito)

1. STRUCTURE:

Engineering polymer monocoque, ral finish or foam padded and upholstered. Round steel bar structure Ø 16mm, with or without armrests, chromed finish (15µm) or powder coated

2. MECHANISM:

Height adjustable, Black finish

3. BASE:

- Polished aluminium 5 spoke base, Ø670 mm
- Fiberglass reinforced polyamide 5 spoke base, Ø640 mm, black finish

4. CASTORS/FEET:

- Ø 50 mm self-braking castors, or soft self-bracking. Black finish
- h.61 mm polyamide glides, black finish

5. ARMREST:

Steel round bar Ø12 mm, triangular armrest, chromed finish (15µm) or powder coated. Padded and upholstered

1. STRUCTURE:

Monocoque en polymère technique, finition RAL ou rembourrée de mousse et tapissée. Structure de support en tube d'acier, Ø16mm, avec ou sans accoudoirs, finition chromé (15µm) o verni époxy

2. MECANISME:

Réglable en hauteur, finition noir

3. PIÈTEMENT:

- Piètement 5 branches alu poli, Ø 670mm
- Piètement 5 branches en polyamide renforcé en fibre de verre, Ø640mm, finition noir

4. ROULETTES/PATINS:

- Roulettes Ø 50mm, autofreinantes ou gommées, finition chromé ou noir
- Patins en polyamide, h.61mm, finition noir

5. ACCOUDOIR:

Accoudoir triangulaire en tige d'acier, Ø 12mm, finition chromé (15µm) ou verni époxy (manchette rembourrée et tapissée)

1. STRUKTUR:

Technopolymer Schale, RAL Farben oder ausgepolstert mit Schaumstoff und Bezug, Rund-Stahlrohrgestell Ø 16 mm, mit oder ohne Armlehnen, verchromt (15µm) oder pulverbeschichtet

2. MECHANIK:

Sitzhöhenverstellung, drehbar, verchromt

3. GESTELL:

- 5-Stern Alu poliertes Fußkreuz, Ø 670 mm
- 5-Stern schwarzes glasfaserverstärktes Polyamid Fußkreuz, Ø640 mm

4. ROLLEN/GLEITER:

- Ø 50 mm gebremste, oder weiche gebremste Rollen, schwarz oder verchromt
- Polyamidgleiter, H.61 mm, schwarz

5. ARMLEHNE:

Feste dreieckige Armlehne aus Stahlstab, Ø 12 mm, verchromt (15µm) oder pulverbeschichtet, ausgepolstert mit Bezug

1. ESTRUCTURA:

Monocasco de tecnopolimero, acabado RAL o acolchado con espuma y recubierto en tejido, con estructura de soporte en tubo de acero redondo, Ø16mm, con o sin brazos, acabado cromado (15µm) o con recubrimiento en polvo

2. MECANISMO:

Control de elevación de gas, acabado negro

3. BASE:

- Base de 5 estrellas en aluminio, Ø 670mm, acabado brillante
- Base de 5 radios en poliamida con carga de fibra de vidrio, Ø640mm, acabado negro

4. RUEDAS / PIES:

- Ruedas de Ø 50 mm, autofrenado o autofrenado y blandas, acabado negro
- Pies en poliamida, h. 61mm, acabado negro

5. BRAZOS:

Brazos triangular de acero redondo, Ø 12 mm, acabado cromado (15µm) o con recubrimiento en polvo (acolchado y tapizado)



ID 1111209613

SLIM Task

GIREVOLE, SCOCCA IN TECNOPOLIMERO
 SWIVEL, ENGINEERING POLIMER SHELL
 PIVOTANT, COQUE EN POLYMÈRE TECHNIQUE
 DREHBAR, TECHNOLYMER SCHALE
 GIRATORIA, CONCHA EN TECNOPOLÍMERO

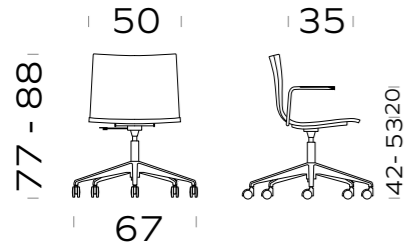

Mechanism: **SeatPlate**↑↓

Regolazione altezza
 Height adjustment
 Réglage en hauteur
 Höhenverstellung
 Ajuste de altura



BASE BASE PIETEMENT GESTELL BASE	RUOTA/PIEDINO CASTOR/FEET ROULETTES/PATINS ROLLEN/GLEITER RUEDAS/PIES	STRUTTURA STRUCTURE STRUCTURE STRUKTUR ESTRUCTURA	VARIANTE VARIANT VARIANTE VARIANTE VARIANTE	CODICE CODE CODE ARTIKEL CÓDIGO	KG	PREZZO PRICE PRIX PREIS PRECIO
						SHELL RAL
			con braccioli with arms avec accoudories mit Armlehnen con brazos	SL0334	8,90	242
			senza braccioli without arms sans accoudories ohne Armlehnen sin brazos	SL0323	7,80	218
			con braccioli with arms avec accoudories mit Armlehnen con brazos	SL0074	9,00	350
			senza braccioli without arms sans accoudories ohne Armlehnen sin brazos	SL0045	7,90	320

STRUCTURE RAL	SHELL RAL
<p>* DISPONIBILE ANCHE IN ALSO AVAILABLE ÉGALEMENT DISPONIBLE EN ERHÄLTICH AUCH IN TAMBIÉN DISPONIBLE EN</p> <p>RAL 9016</p> <p>RAL 1012</p> <p>RAL 3012</p> <p>RAL 6021</p> <p>RAL 7032</p> <p>RAL 7046</p>	<p>RAL 9016</p> <p>RAL 1012</p> <p>RAL 3012</p> <p>RAL 3001</p> <p>RAL 6021</p> <p>RAL 7032</p> <p>RAL 5009</p> <p>RAL 7046</p> <p>RAL 9005</p> <p>RAL 9016</p>

* DISPONIBILE ANCHE CON
 ALSO AVAIBLE WITH
 ÉGALEMENT DISPONIBLE AVEC
 ERHÄLTICH AUCH MIT
 TAMBIÉN DISPONIBLE CON

d.50 mm autofrenanti
 self-braking d.50mm
 d.50mm autofreinante
 gebremste D.50mm
 diam.50 autofreno

SAME PRICE

SLIM Task Stool

GIREVOLE, SCOCCA IN TECNOPOLIMERO
 SWIVEL, ENGINEERING POLIMER SHELL
 PIVOTANT, COQUE EN POLYMÈRE TECHNIQUE
 DREHBAR, TECHNOLYMER SCHALE
 GIRATORIA, CONCHA EN TECNOPOLÍMERO

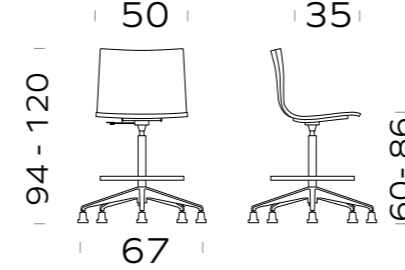

Mechanism: **SeatPlate**↑↓

Regolazione altezza
 Height adjustment
 Réglage en hauteur
 Höhenverstellung
 Ajuste de altura



BASE BASE PIETEMENT GESTELL BASE	RUOTA/PIEDINO CASTOR/FEET ROULETTES/PATINS ROLLEN/GLEITER RUEDAS/PIES	STRUTTURA STRUCTURE STRUCTURE STRUKTUR ESTRUCTURA	VARIANTE VARIANT VARIANTE VARIANTE VARIANTE	CODICE CODE CODE ARTIKEL CÓDIGO	KG	PREZZO PRICE PRIX PREIS PRECIO
						SHELL RAL
			con braccioli with arms avec accoudories mit Armlehnen con brazos	SL0081	9,50	367
			senza braccioli without arms sans accoudories ohne Armlehnen sin brazos	SL0052	8,50	338

OPZIONE OPTIONALS OPTIONS OPTIONEN OPCIONES	VARIANTE VARIANT VARIANTE VARIANTE VARIANTE	CODICE CODE CODE ARTIKEL CÓDIGO	KG	PREZZO PRICE PRIX PREIS PRECIO
	Anello poggiapiedi in alluminio Aluminium footrest ring Appui-pieds circulaire en aluminium Ringfußstütze aus Aluminium Reposapiés anello en aluminio	XP004	1,20	106

SHELL RAL
<p>RAL 9016</p> <p>RAL 1012</p> <p>RAL 3012</p> <p>RAL 3001</p> <p>RAL 6021</p> <p>RAL 7032</p> <p>RAL 5009</p> <p>RAL 7046</p> <p>RAL 9005</p> <p>RAL 9016</p>

SLIM Bench

idea: *Pietro Lovato*



TECHNICAL INFORMATION

1. STRUTTURA:

Trave 2/3/4 posti con monoscocca in tecnopolimero, finitura RAL o imbottita con spugna e rivestita, con struttura di sostegno in tubo tondo d'acciaio, Ø 16mm, finitura cromata (15µm) o verniciata a polveri (tavolino in lamina d'acciaio, finitura verniciata a polveri)

2. BASE:

Trave in tubo rettangolare d'acciaio 60x20mm, finitura verniciata a polveri con gambe in tubo d'acciaio Ø20mm, finitura cromata (15µm) o verniciata a polveri

3. BRACCIOLI:

Bracciolo triangolare in tondo d'acciaio, Ø 12mm, finitura cromata (15µm) o verniciata a polveri (imbottito e rivestito)

1. STRUCTURE:

2/3/4 seats bench, with Engineering polymer monocoque, ral finish or foam padded and upholstered. Round steel bar structure Ø16mm, with or whitout armrests, chromed finish (15µm) or powder coated. (metal sheet coffee table, powder coated)

2. BASE:

Rect. Steel tube bar 60x20mm, powder coated, with steel tube legs Ø20mm, chromed finish (15µm) or powder coated

3. ARMREST:

Steel round bar Ø12 mm, triangular armrest, chromed finish (15µm) or powder coated. Padded and upholstered

1. STRUCTURE:

Poutre 2/3/4 places avec monocoque en polymère technique, finition RAL ou rembourrée de mousse et tapissée. Structure de support en tube d'acier, Ø 16mm, finition chromé (15µm) o verni époxy (tablette en acier, finition verni époxy)

2. PIÈTEMENT:

Poutre en tube d'acier rectangulaire, 60x20mm, finition verni époxy avec pieds en tube d'acier Ø 20mm, finition chromé (15µm) ou verni époxy

3. ACCOUDOIR:

Accoudoir triangulaire en tige d'acier, Ø 12mm, finition chromé (15µm) ou verni époxy (manchette rembourrée et tapissée)

1. STRUKTUR:

2/3/4 Sitz Stahlbalken, mit Technopolymer Schale, Ral Farben oder ausgepolster mit Schaumstoff und Bezug, Rund-Stahlrohrgestell Ø 16 mm, verchromt (15µm) oder pulverbeschichtet. (Stahlband-Ablageplatte, pulverbeschichtet)

2. GESTELL:

Rechteckige Stahlrohrrahmen, 60x20 mm, pulverbeschichtet mit Stahlrohrbeine, Ø 20 mm, verchromt 15 µm) oder pulverbeschichtet

3. ARMLEHNE:

Feste dreieckige Armlehne aus Stahlstab, Ø 12 mm, verchromt (15µm) oder pulverbeschichtet, ausgepolstert mit Bezug

1. ESTRUCTURA:

Banco de 2/3/4 plazas con monoscasca de tecnopolimero, acabado RAL o acolchado con espuma y tapizado, con estructura de soporte en tubo de acero redondo, Ø16mm, acabado cromado (15µm) o con recubrimiento en polvo (mesa en chapa de acero con recubrimiento en polvo)

2. BASE:

Viga en tubo de acero rectangular de 60x20mm, acabado con recubrimiento en polvo con patas en tubo de acero de Ø20mm, acabado en cromo (15 µm) o con recubrimiento en polvo

3. BRAZOS:

Brazos triangular de acero redondo, Ø 12 mm, acabado cromado (15µm) o con recubrimiento en polvo (acolchado y tapizado)



SLIM Bench

SCocca IN TECNopolImERO, STRuTTURA IN METALLO
 ENGINEERING POLIMER SHELL, METAL STRUCTURE
 COQUE EN POLYMERÉ TECHNIQUE, STRUCTURE EN MÉTAL
 TECHNOLYMER SCHALE, METALSTRUKTUR
 CONCHA EN TECNOLÍMERO, ESTRUCTURA EN METAL

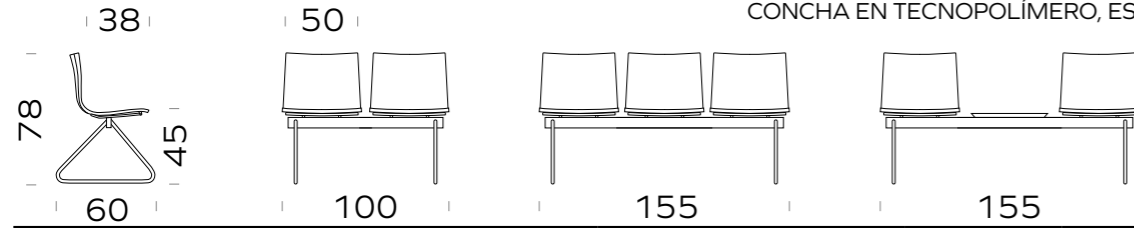

BASE BASE PIETEMET GESTELL BASE	RUOTA/PIEDINO CASTOR/FEET ROULETTES/PATINS ROLLEN/GLEITER RUEDAS/PIES	GAMBE LEGS PIEDS FUßGESTELL PATAS	CODICE CODE CODE ARTIKEL CODIGO	KG	PREZZO PRICE PRIX PREIS PRECIO
					SHELL RAL
 trave nera 2 posti con gambe black shell 2 seats bench with legs noire poutre 2 places avec pies Schwarz 2 Sitzträger mit Fußgestell negra bancada 2 asientos con patas		 Chromed	SL0204	19,20	525
			 RAL 9005 *	SL0210	19,20
 trave nera 3 posti con gambe black shell 3 seats bench with legs noire poutre 3 places avec pies Schwarz 3 Sitzträger mit Fußgestell negra bancada 3 asientos con patas		 Chromed	SL0240	25,70	736
			 RAL 9005 *	SL0246	25,70
 trave nera 2 posti con gambe + tavolo vern. nero black shell 2 seats bench with legs + black painted table noire poutre 2 places avec pies + tablette vernie noire Schwarz 2 Sitzträger mit Fußgestell + schwarze Ablagep. negra bancada 2 asientos con patas + mesa pintada negro		 Chromed	SL0244	25,20	651
			 RAL 9005 *	SL0250	25,20

* STRUCTURE RAL	SHELL RAL
<p>DISPONIBILE ANCHE IN ALSO AVAILABLE ÉGALEMENT DISPONIBLE EN ERHÄLTlich AUCh IN TAMBIÉN DISPONIBLE EN</p> RAL 9016 RAL 1012 RAL 3012	 RAL 9016 RAL 1012 RAL 3012 RAL 3001 RAL 6021
 RAL 6021 RAL 7032 RAL 7046	 RAL 7032 RAL 5009 RAL 7046 RAL 9005 RAL 9016

SLIM Bench

SCocca IN TECNopolImERO, STRuTTURA IN METALLO
 ENGINEERING POLIMER SHELL, METAL STRUCTURE
 COQUE EN POLYMERÉ TECHNIQUE, STRUCTURE EN MÉTAL
 TECHNOLYMER SCHALE, METALSTRUKTUR
 CONCHA EN TECNOLÍMERO, ESTRUCTURA EN METAL

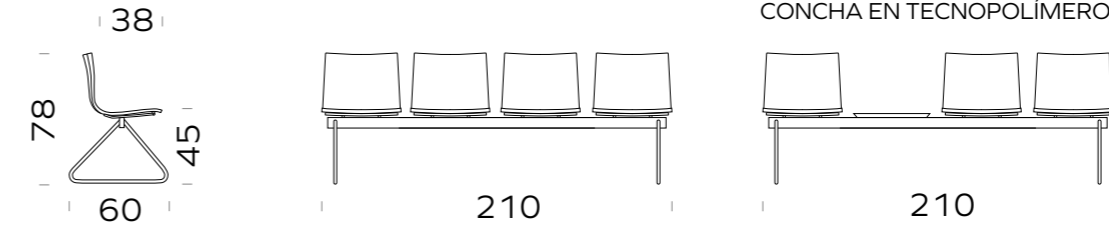











BASE BASE PIETEMET GESTELL BASE	RUOTA/PIEDINO CASTOR/FEET ROULETTES/PATINS ROLLEN/GLEITER RUEDAS/PIES	STRUTTURA STRUCTURE STRUCTURE STRUKTUR ESTRUCTURA	CODICE CODE CODE ARTIKEL CODIGO	KG	PREZZO PRICE PRIX PREIS PRECIO
					SHELL RAL
 trave nera 4 posti con gambe black shell 4 seats bench with legs noire poutre 4 places avec pies Schwarz 4 Sitzträger mit Fußgestell negra bancada 4 asientos con patas		 Chromed	SL0276	30,50	944
			 RAL 9005 *	SL0282	30,50
 trave nera 3 posti con gambe + tavolo vern. nero black shell 3 seats bench with legs + black painted table noire poutre 3 places avec pies + tablette vernie noire Schwarz 3 Sitzträger mit Fußgestell + schwarze Ablagep. negra bancada 3 asientos con patas + mesa pintada negro		 Chromed	SL0280	30,00	860
			 RAL 9005 *	SL0286	30,00

* STRUCTURE RAL	SHELL RAL
<p>DISPONIBILE ANCHE IN ALSO AVAILABLE ÉGALEMENT DISPONIBLE EN ERHÄLTlich AUCh IN TAMBIÉN DISPONIBLE EN</p> RAL 9016 RAL 1012 RAL 3012	 RAL 9016 RAL 1012 RAL 3012 RAL 3001 RAL 6021
 RAL 6021 RAL 7032 RAL 7046	 RAL 7032 RAL 5009 RAL 7046 RAL 9005 RAL 9016

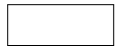
SLIM

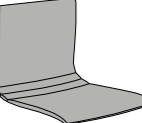
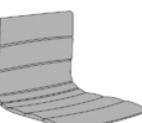
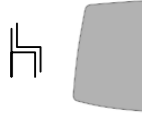
OPTIONALS

OPZIONE OPTIONALS OPTIONS OPTIONEN OPCIONES	VARIANTE VARIANT VARIANTE VARIANTE VARIANTE	CODICE CODE CODE ARTIKEL CÓDIGO	KG	PREZZO PRICE PRIX PREIS PRECIO	TESSUTI/FINITURE UPHOLSTERIES/FINISHING REVETEMENTS STOFFGRUPPE TAPICERIAS				
					D	E	F	G	H
	 Chromed	XB030	2,30	84					
	*  RAL 9005	XB035	2,30	82					
	 Chromed	XB040	2,30		112	112	112	112	
	*  RAL 9005	XB042	2,30		110	110	110	110	
	SHELL FIREPROOF ONLY FOR  RAL 9016	XI018	2,20	46					
	SEAT CUSHION	XC017	0,80		39	44	50	53	62
	UPHOLSTERED	XA022	0,50		97	102	120	172	198
	UPHOLSTERED	XA014	0,50		97	102	120	172	198
	Tavoletta scrittoio destra Right-hand writing tablet Tablette écriteoire droite Schreibplatte rechts Pala escritorio derecha	XS003	1,30	63					
	Tavolino scrittoio girevole Wide swivel writing tablet Tablette pivotante grande Drehbare Schreibtafel Pala giratoria escritorio	XS002	2,80	253					

* DISPONIBILE ANCHE IN
ALSO AVAILABLE
ÉGALEMENT DISPONIBLE EN
ERHÄLTlich AUCH IN
TAMBIÉN DISPONIBLE EN



RAL 9016



RAL 6021



RAL 1012



RAL 7032





RAL 3012



RAL 7046

SLIM

OPTIONALS

OPZIONE OPTIONALS OPTIONS OPTIONEN OPCIONES	VARIANTE VARIANT VARIANTE VARIANTE VARIANTE	CODICE CODE CODE ARTIKEL CÓDIGO	KG	PREZZO PRICE PRIX PREIS PRECIO	TESSUTI/FINITURE UPHOLSTERIES/FINISHING REVETEMENTS STOFFGRUPPE TAPICERIAS				
					D	E	F	G	H
 *	pedini agganciabili con feltrini attachment feet with felts crochet d'accrocheavec feutres Einklappbare schwarze Filzgleiter pies acoplables con fieltros	XA024		4					
	ONLY FOR SL0023 SL0025								
	gancio di agganciabilità alta high attachability hook crochet à haute attachabilité Haken mit hoher Ankoppelbarkeit gancho de alta enganchabilidad	XA007	0,10	3					

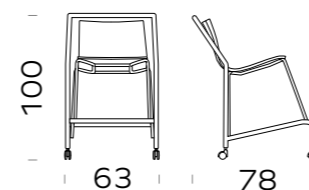
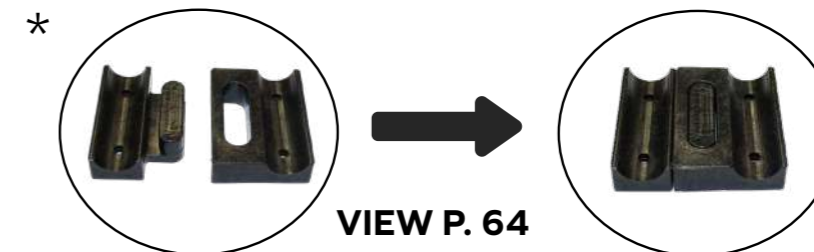

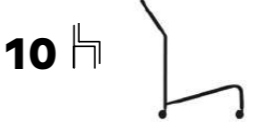
OPZIONE OPTIONALS OPTIONS OPTIONEN OPCIONES	VARIANTE VARIANT VARIANTE VARIANTE VARIANTE	CODICE CODE CODE ARTIKEL CÓDIGO	KG	PREZZO PRICE PRIX PREIS PRECIO
	Carrello porta sedie Chair trolley Chariot porte-chaises Stapelstuhlwagen Carro para transporte de sillas	XA009	5,30	232

ISY

idea: *Pietro Lovato*



1

2

3

4

TECHNICAL INFORMATION

1. SCHIENALE:

Schienale in tubo d'acciaio integrato alla base, rivestito in rete

2. SEDILE:

Sedile in multistrato di legno con spugna alto spessore (55 mm) rivestita. Sottosedile in polipropilene

3. BASE:

- Base a slitta in tubo d'acciaio Ø 16mm, finitura cromata (15µm) o verniciata a polveri
- Base 4 gambe in tubo d'acciaio Ø 16mm, finitura cromata (15µm) o verniciata a polveri

4. RUOTE/PIEDINI:

Tappi in polipropilene neri o bianchi

1. BACKREST:

Base integrated steel tube backrest, mesh upholstered

2. SEAT:

Plywood seat with high thickness foam (55 mm). Underseat in polypropylene

3. BASE:

- Sled base, Ø 16mm steel tube, chromed finish (15µm) or powder coated
- 4 Legs base, Ø 16 mm steel tube, chromed finish (15µm) or powder coated

4. CASTORS/FEET:

Polypropylene plugs, black or white finish

1. DOSSIER:

Dossier en tube d'acier intégré au piètement, revêtu en résille

2. ASSISE:

Assise en multiplis de bois avec mousse haute épaisseur (55 mm). Sous-assise en polypropylène

3. PIÈTEMENT:

- Piètement luge en tube d'acier Ø 16mm, finition chromé (15µm) ou verni époxy
- Piètement 4 pieds en tube d'acier Ø 16mm, finition chromé (15µm) ou verni époxy

4. ROULETTES/PATINS:

Patins en polypropylène, finition noir ou blancs

1. RÜCKENLEHNE :

Rückenlehne mit Stahlrohrrahmen mit Netzbespannung

2. SITZ :

Sperrholzsitz mit 55mm Schaum. Unterseite mit Stapelschutz aus Polypropylen

3. GESTELL :

- Freischwinger Gestell, Ø 16mm Stahlrohr verchromt (15µm) oder pulverbeschichtet
- 4-Fuß Gestell, Ø 16mm Stahlrohr verchromt (15µm) oder pulverbeschichtet

4. ROLLEN/GLEITER :

Polypropylen Gleiter, schwarz oder weiß

1. RESPALDO:

Respaldo en tubo de acero integrado en la base y tapizado en malla

2. ASIENTO:

Asiento en madera contrachapada con espuma de alta grosura (55 mm) tapizado. Debajo del asiento en polipropileno

3. BASE:

- Base de trineo en tubo de acero de Ø 16 mm, acabado cromado (15µm) o con recubrimiento en polvo
- Base de 4 patas en tubo de acero de Ø 16 mm, acabado cromado (15µm) o con recubrimiento en polvo

4. RUEDAS / PIES:

Tapones de polipropileno, acabado negro or blanco



ISY

SCHIENALE IN RETE, STRUTTURA IN METALLO
 MESH BACKREST, METAL STRUCTURE
 DOSSIER EN RÉSILLE, STRUCTURE EN METAL
 NETZ RÜCKENLEHNE, METALLSTRUKTUR
 RESPALDO EN MALLA, ESTRUCTURA EN METAL

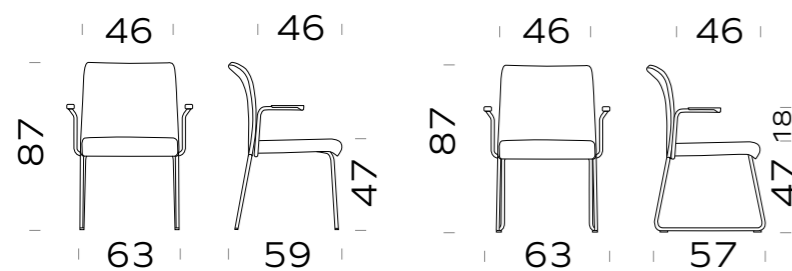

BASE BASE PIETEMET GESTELL BASE	RUOTA/PIEDINO CASTOR/FEET ROULETTES/PATINS ROLLEN/GLEITER RUEDAS/PIES	STRUTTURA STRUCTURE STRUCTURE STRUKTUR ESTRUCTURA	VARIANTE VARIANT VARIANTE VARIANTE VARIANTE	CODICE CODE CODE ARTIKEL CÓDIGO	KG	RETE MESH RÉSILLE NETZ MALLA	TESSUTI/FINITURE UPHOLSTERIES/FINISHING REVETEMENTS STOFFGRUPPE TAPICERÍAS			
							D	E	F	G
4 gambe 4-legs 4 pieds 4-Fuß Gestell 4 patas	tappi plugs patins Gleiter tapos	Chromed	con braccioli with arms avec accoudories mit Armlehnen con brazos	IS0009	5,50	M-N	339	340	349	392
			senza braccioli without arms sans accoudories ohne Armlehnen sin brazos	IS0004	4,80	M-N	288	289	296	341
		RAL 9005	con braccioli with arms avec accoudories mit Armlehnen con brazos	IS0008	5,50	M-N	301	302	312	354
			senza braccioli without arms sans accoudories ohne Armlehnen sin brazos	IS0006	4,80	M-N	256	259	267	312
		Chromed	con braccioli with arms avec accoudories mit Armlehnen con brazos	IS0012	6,30	M-N	362	365	373	417
			senza braccioli without arms sans accoudories ohne Armlehnen sin brazos	IS0010	5,60	M-N	314	316	325	368
RAL 9005	con braccioli with arms avec accoudories mit Armlehnen con brazos	IS0011	6,30	M-N	325	327	335	379		
	senza braccioli without arms sans accoudories ohne Armlehnen sin brazos	IS0007	5,60	M-N	282	286	294	338		

* DISPONIBILE ANCHE IN
 ALSO AVAILABLE
 ÉGALEMENT DISPONIBLE EN
 ERHÄLTlich AUCH IN
 TAMBIÉN DISPONIBLE EN



RAL 9016



RAL 1012



RAL 3012



RAL 6021



RAL 7032



RAL 7046

ISY

OPTIONALS

OPZIONE OPTIONALS OPTIONS OPTIONEN OPCIONES	VARIANTE VARIANT VARIANTE VARIANTE VARIANTE	CODICE CODE CODE ARTIKEL CÓDIGO	KG	PREZZO PRICE PRIX PREIS PRECIO
	Carrello porta sedie Chair trolley Chariot porte-chaises Stapelstuhwagen Carro para transporte de sillas	XA009	5,30	232
	Tavoletta scrittoio destra Right-hand writing tablet Tablette écrite droite Schreibplatte rechts Pala escritorio derecha	XS003	1,30	63
	pedini agganciabili con feltrini attachment feet with felts crochet d'accroche avec feutres Einklappbare schwarze Filzgleiter pies acoplables con feltros	XA024		4

*

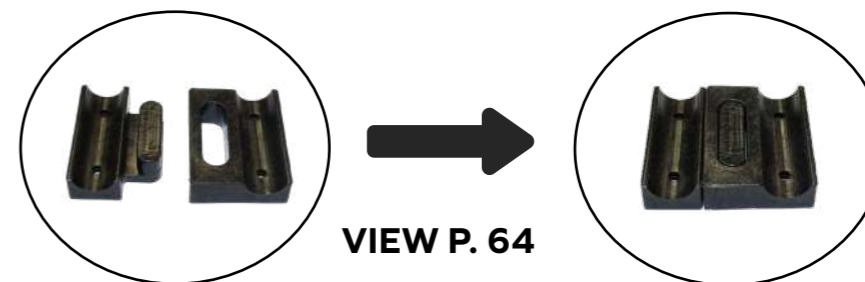

VIEW P. 64

SLIM Attachable

idea: *Pietro Lovato*

1
2
3



ATTACHABLE FEET

ISY Attachable

idea: *Pietro Lovato*

1
2
3
4



ATTACHABLE FEET

SLIM Attachable

TECHNICAL INFORMATION

1. SCOCCA:

Monoscocca in tecnopolimero, finitura RAL o imbottita con spugna e rivestita, con struttura di sostegno in tubo tondo d'acciaio, Ø 16mm, finitura cromata (15µm) o verniciata a polveri

2. BASE:

• Base a slitta in tubo d'acciaio Ø 16mm, finitura cromata (15µm) o verniciata a polveri

3. PIEDINI:

• Tappi in polipropilene, finitura nera o bianca

PIEDINI AGGANCIABILI

Piedini agganciabili neri in polimero con feltrini

1. SHELL:

Engineering polymer monocoque, ral finish or foam padded and upholstered. Round steel bar structure Ø16mm, chromed finish (15µm) or powder coated

2. BASE:

• Cantilever base, Ø 16 mm steel tube, chromed finish (15µm) or powder coated

3. FEET:

• polypropylene plugs, black or white finish

ATTACHMENT FEET

Black Polymer attachment feet with felts

1. COQUE:

Monocoque en polymère technique, finition RAL ou rembourrée de mousse et tapissée. Structure de support en tube d'acier, Ø16mm, finition chromé (15µm) ou verni époxy

2. PIÈTEMENT:

• Piètement luge en tube d'acier Ø 16mm, finition chromé (15µm) ou verni époxy

3. PATINS:

• Tappons en polypropylène, finition noir ou blanc

CROCHET D'ACCROCHE

Crochet d'accroche noirs en polymère avec feutres

1. SCHALE:

Technopolymer Schale, RAL Farben oder ausgepolstert mit Schwamm und Stoffbezug, Rund-Stahlrohrgestell Ø 16 mm, verchromt (15 µm) oder pulverbeschichtet

2. GESTELL:

• Kufengestell, Ø 16mm Stahlrohr, verchromt (15µm) oder pulverbeschichtet

3. GLEITER:

• Polyamid gleiter, schwarze oder weisse

EINKLAPPBARE GLEITER

Einklappbare schwarze Filzgleiter aus Polymer

1. CASCO:

Monocasca de tecnopolimero, acabado RAL o acolchado con espuma y recubierto en tejido, con estructura de soporte en tubo de acero redondo, Ø16mm, acabado cromado (15 µm) o con recubrimiento en polvo

2. BASE:

• Base de trineo en tubo de acero de Ø 16 mm, acabado cromado (15 µm) o con recubrimiento en polvo

3. PIES:

• Tapones de polipropileno, acabado negro o blanco.

PIES ACOPLABLES

Pies acoplables negro en polimero con fieltros



ID 1111209613

ISY Attachable

TECHNICAL INFORMATION

1. SCHIENALE:

Schienale in tubo d'acciaio integrato alla base, rivestito in rete

2. SEDILE:

Sedile in multistrato di legno con spugna alto spessore (55 mm) rivestita. Sottosedile in polipropilene

3. BASE:

• Base a slitta in tubo d'acciaio Ø 16mm, finitura cromata (15µm) o verniciata a polveri

4. PIEDINI:

• Tappi in polipropilene neri o bianchi

PIEDINI AGGANCIABILI

Piedini agganciabili neri in polimero con feltrini

1. BACKREST:

Base integrated steel tube backrest, mesh upholstered

2. SEAT:

Plywood seat with high tickness foam (55 mm). Undersat in polypropylene

3. BASE:

• Sled base, Ø 16mm steel tube, chromed finish (15µm) or powder coated

4. FEET:

• Polypropylene plugs, black or white finish

ATTACHMENT FEET

Black Polymer attachment feet with felts

1. DOSSIER:

Dossier en tube d'acier intégré au piètement, revetu en résille

2. ASSISE:

Assise en multiplis de bois avec mousse haute épaisseur (55 mm). Sous-assise en polypropilène

3. PIÈTEMENT:

• Piètement luge en tube d'acier Ø 16mm, finition chromé (15µm) ou verni époxy

4. PATINS:

• Patins en polypropylène, finition noir ou blancs

CROCHET D'ACCROCHE

Crochet d'accroche noirs en polymère avec feutres

1. RÜCKENLEHNE:

Rückenlehne mit Stahlrohrrahmen mit Netzbespannung

2. SITZ:

Sperrholzsitz mit 55mm Schaum. Unterseite mit Stapelschutz aus Polypropylen

3. GESTELL:

• Freischwinger Gestell, Ø 16mm Stahlrohr verchromt (15µm) oder pulverbeschichtet

4. GLEITER:

• Polypropylen Gleiter, schwarz oder weiß

EINKLAPPBARE GLEITER

Einklappbare schwarze Filzgleiter aus Polymer

1. RESPALDO:

Respaldo en tubo de acero integrado en la base y tapizado en malla

2. ASIENTO:

Asiento en madera contrachapada con espuma de alta grosura (55 mm) tapizado. Debajo del asiento en polipropileno

3. BASE:

• Base de trineo en tubo de acero de Ø 16 mm, acabado cromado (15µm) o con recubrimiento en polvo

4. PIES:

• Tapones de polipropileno, acabado negro or blanco

PIES ACOPLABLES

Pies acoplables negro en polimero con fieltros



SLIM Attachable

SEDUTA AGGANCIABILE, SCOCCA IN TECNOPOLIMERO, STRUTTURA IN METALLO
 ATTACHABLE SEAT, ENGINEERING POLIMER SHELL, METAL STRUCTURE
 SIÈGE ACCROCHABLE, COQUE EN POLYMÈRE TECHNIQUE, STRUCTURE EN MÉTAL
 STUHL ANSTECKBAR, TECHNOLYMER SCHALE, METALSTRUKTUR
 ASIENTO ACOPLABLE, CONCHA EN TECNOPOLÍMERO, ESTRUCTURA EN METAL

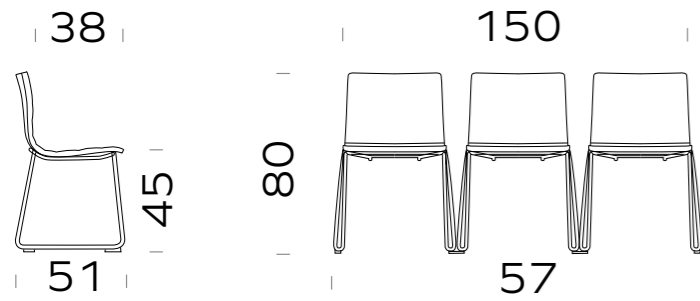



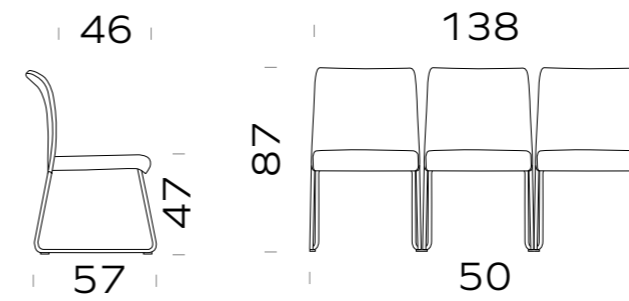

ISY Attachable









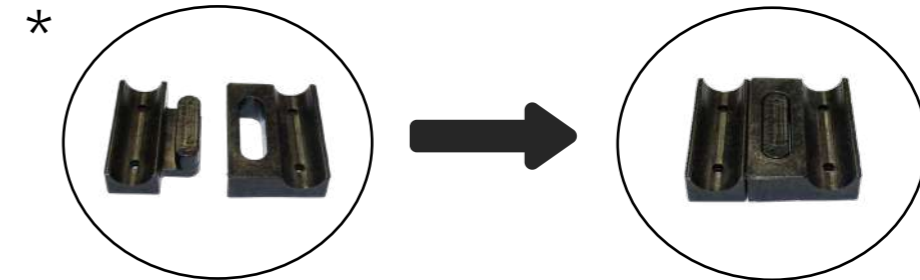







SEDUTA AGGANCIABILE, SCHIENALE IN RETE, STRUTTURA IN METALLO
 ATTACHABLE SEAT, MESH BACKREST, METAL STRUCTURE
 SIÈGE ACCROCHABLE, DOSSIER EN RESILLE, STRUCTURE EN METAL
 STUHL ANSTECKBAR, NETZ RÜCKENLEHNE, METALLSTRUKTUR
 ASIENTO ACOPLABLE, RESPALDO EN MALLA, ESTRUCTURA EN METAL



BASE BASE PIETEMET GESTELL BASE	RUOTA/PIEDINO CASTOR/FEET ROULETTES/PATINS ROLLEN/GLEITER RUEDAS/PIES	AGGANCIABILITÀ ATTACHABILITY ACCROCHABILITÉ ANSTECKBAR SISTEMA DE ENGANCHE	STRUTTURA STRUCTURE STRUCTURE STRUKTUR ESTRUCTURA	CODICE CODE CODE ARTIKEL CÓDIGO	KG	PREZZO PRICE PRIX PREIS PRECIO
						SHELL RAL
				SL0468	5,40	200
						Chromed
slitta sled luge Kufengestell patin	tappi plugs patins Gleiter tapos	* pedini agganciabili con feltrini attachment feet with felts crochet d'accroche avec feutres Einklappbare schwarze Filzgleiter pies acoplables con feltros		SL0469	5,40	194
						RAL 9005 *

BASE BASE PIETEMET GESTELL BASE	RUOTA/PIEDINO CASTOR/FEET ROULETTES/PATINS ROLLEN/GLEITER RUEDAS/PIES	AGGANCIABILITÀ ATTACHABILITY ACCROCHABILITÉ ANSTECKBAR SISTEMA DE ENGANCHE	STRUTTURA STRUCTURE STRUCTURE STRUKTUR ESTRUCTURA	CODICE CODE CODE ARTIKEL CÓDIGO	KG	RETE MESH RÉSILLE NETZ MALLA	TESSUTI/FINITURE UPHOLSTERIES/FINISHINGS REVÊTEMENTS STOFFGRUPPE TAPICERIAS			
							D	E	F	G
		* 		IS0003	5,60	M-N	318	320	329	372
							Chromed			
slitta sled luge Kufengestell patin	tappi plugs patins Gleiter tapos	* pedini agganciabili con feltrini attachment feet with felts crochet d'accroche avec feutres Einklappbare schwarze Filzgleiter pies acoplables con feltros		IS0002	5,60	M-N	286	290	298	342
							RAL 9005 *			



* STRUCTURE RAL	SHELL RAL
<p>DISPONIBILE ANCHE IN ALSO AVAILABLE ÉGALEMENT DISPONIBLE EN ERHÄLTICH AUCH IN TAMBIÉN DISPONIBLE EN</p>  RAL 9016  RAL 1012  RAL 3012	 RAL 9016  RAL 1012  RAL 3012  RAL 3001  RAL 6021
 RAL 6021  RAL 7032  RAL 7046	 RAL 7032  RAL 5009  RAL 7046  RAL 9005  RAL 9016

* DISPONIBILE ANCHE IN
 ALSO AVAILABLE
 ÉGALEMENT DISPONIBLE EN
 ERHÄLTICH AUCH IN
 TAMBIÉN DISPONIBLE EN



TECHNICAL INFORMATION

1. STRUTTURA:

Schienale e sedile imbottiti,
piano in mdf laccato sp. 28mm,
struttura in acciaio

2. PIEDINI:

Struttura in trafilato d'acciaio,
35x5mm, finitura cromata (15µm)

1. STRUCTURE:

Upholstered seat and backseat,
28mm lacquered mdf top, steel
structure

2. FEET:

Steel plate structure,
35x5mm, chromed finish (15µm)

1. STRUCTURE:

Assise et dossier tapissés,
plateau en mdf laqué,
ép. 28Mm, piètement en acier

2. PATINS:

Structure en acier étiré,
35x35mm, finition chromé
(15µm)

1. GESTELL:

Sitz und rückenfläche gepolstert,
28 mm lackierte mdf platte

2. GLEITER:

Stahlstruktur, 35x5 mm,
verchromt (15µm)

1. ESTRUCTURA:

Asiento y respaldo tapizados,
hoja en mdf lacado 28mm esp,
estructura en acero

2. PIES:

Estructura en acero estirado,
35x5mm, acabado cromado
(15µm).

ELETTRA





idea: *Pietro Lovato*

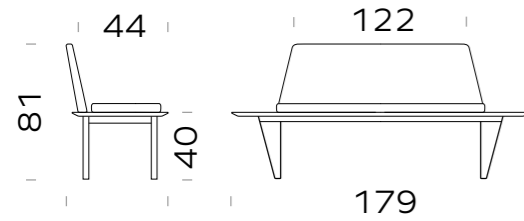







ELETTRA



SCHIENALE E SEDILI IMBOTTITI, PIANO IN MDF LACCATO SP. 28MM,
 STRUTTURA IN ACCIAIO
 UPHOLSTERED SEAT AND BACKSEAT, 28MM LACQUERED MDF TOP,
 STEEL STRUCTURE
 ASSISE ET DOSSIER TAPISSÉS, PLATEAU EN MDF LAQUÉ, ÉP. 28MM
 PIÈTEMENT EN ACIER
 SITZ UND RÜCKENFLÄCHE GEPOLSTERT, 28MM LACKIERTE MDF PLATTE
 ASIENTO Y RESPALDO TAPIZADOS, HOJA EN MDF LACADO 28MM ESP,
 ESTRUCTURA EN HACERO

STRUTTURA STRUCTURE STRUCTURE STRUKTUR ESTRUCTURA	RUOTA/PIEDINO CASTOR/FEET ROULETTES/PATINS ROLLEN/GLEITER RUEDAS/PIES	BASE BASE PIÈTEMENT GESTELL BASE	CODICE CODE CODE ARTIKEL CÓDIGO	KG	PIANO MDF MDF TOP PLATEAU EN MDF MDF PLATTE HOJA EN MDF	TESSUTI/FINITURE UPHOLSTERIES/FINISHING REVÊTEMENTS STOFFGRUPPE TAPICERIAS				
						D	E	F	G	H
 struttura in acciaio steel structure structure en acier Stahlgestell estructura en hacero	 feltrini felts feutres Filzgleiter fieltros	 Chromed	EL0001	41,40	MDF RAL	1754	1783	1827	1990	2848
		 RAL 9005 *	EL0002	41,40	MDF RAL	1754	1783	1827	1990	2848

 MOVING

STRUCTURE RAL	MDF RAL
<p>* DISPONIBILE ANCHE IN ALSO AVAILABLE ÉGALEMENT DISPONIBLE EN ERHÄLTlich AUCH IN TAMBIÉN DISPONIBLE EN</p> <div style="display: flex; justify-content: space-around;"> <div style="text-align: center;">  RAL 9016 </div> <div style="text-align: center;">  RAL 1012 </div> <div style="text-align: center;">  RAL 3012 </div> </div> <div style="display: flex; justify-content: space-around; margin-top: 10px;"> <div style="text-align: center;">  RAL 6021 </div> <div style="text-align: center;">  RAL 7032 </div> <div style="text-align: center;">  RAL 7046 </div> </div>	<p>DISPONIBILE IN COLORE UN RAL A SCELTA AVAILABLE IN A SELECTED RAL COLOR DISPONIBLE DANS UNE COULEUR RAL AU CHOIX ERHÄLTlich IN AUSWÄHLBARE RAL FARBEN DISPONIBLE EN UN RAL A ELECCIÓN</p> <div style="text-align: center;">  </div>

ZIP

idea: *Pietro Lovato*



TECHNICAL INFORMATION

1. SCHIENALE:

Schienale e sedile in polipropilene, a vista o imbottita con spugna rivestita

2. BASE:

Base 4 gambe in tubo d'acciaio Ø 22mm, finitura cromata (15µm) o verniciata a polveri

3. RUOTE/PIEDINI:

- Ruote Ø 50mm, autofrenanti o autofrenanti e gommate, finitura nera
- Tappi in polipropilene, finitura nera

4. BRACCIOLI:

- Bracciolo fisso in poliamide, finitura nera
- Bracciolo fisso in tubo tondo d'acciaio, Ø 16mm, finitura cromata (15µm) o verniciata a polveri, con top in poliamide, finitura nera

5. TAVOLETTA SCRITTOIO:

Scrittoio in stratificato HPL, finitura nera, con supporto in tubo d'acciaio Ø 25mm, finitura verniciata a polveri

1. BACKREST:

Seat and backrest in polypropylene, or foam padded, upholstery

2. BASE:

4 Legs base, Ø 22 mm steel tube, chromed finish (15µm) or powder coated

3. CASTORS/FEET:

- Ø 50 mm self-braking castors, or soft self-bracking, Black finish
- polypropylene plugs, black finish

4. ARMREST:

- Polyamide fixed armrest, black finish
- Fixed armrest, round steel tube, Ø 16mm, chromed finish (15µm), or powder coated, polyamide top pad, black finish

5. TABLET:

Hpl multilayer writing tablet, black finish, steel tube Ø25mm structure, powder coated

1. DOSSIER:

Assise et dossier en polypro - pylène à vue ou rembourrés de mousse et tapissés

2. PIÈTEMENT:

Piètement 4 pieds en tube d'acier Ø 22mm, finition chromé (15µm) ou verni époxy

3. ROULETTES/PATINS:

- Roulettes Ø 50mm, autofreinantes ou autofreinantes et gommées, finition noir
- tampons en polypropylène, finition noir

4. ACCOUDOIRS:

- Accoudoir fixe en polyamide, finition noir
- Accoudoir fixe en tube rond d'acier, Ø 16mm, finition chromée (15µm) ou verni époxy, manchette en polyamide, finition noir

5. TABLETTE:

Tablette en stratifié HPL, finition noir, support en tube d'acier Ø 25mm, finition verni époxy

1. RÜCKENLEHNE:

Polypropylen Sitz und Rückenlehne, oder ausgepolstert mit Schaumstoff und Bezug

2. GESTELL:

4-Fuß Gestell, Ø 22mm Stahlrohr, verchromt (15µm) oder pulverbeschichtet

3. ROLLEN/GLEITER:

- Ø 50 mm gebremste, oder weiche gebremste Rollen, schwarz
- polyamid gleiter, schwarz

4. ARMLEHNEN:

- Feste schwarze Polyamid Armlehne
- Feste Armlehne aus Stahlrohr, Ø 16 mm, verchromt (15µm) oder pulverbeschichtet, schwarze Polyamid Armauflage

5. SCHREIBPLATTE:

Schreibplatte, schwarz, mit Stahlrohrträger Ø 25 mm, verchromt oder pulverbeschichtet

1. RESPALDO:

Respaldo y asiento en polipropileno, visible o tapizado con una espuma cubierta

2. BASE:

Base de 4 patas en tubo de acero de Ø 22 mm, acabado cromado (15µm) o con recubrimiento en polvo

3. RUEDAS / PIES:

- Ruedas de Ø 50 mm, autofrenado o autofrenado y acabado de goma, negro
- Tapones de polipropileno, acabado negro

4. BRAZOS:

- Reposabrazos fijo en poliamida, acabado negro.
- Reposabrazos fijos en tubo de acero redondo, Ø 16 mm, acabado cromado (15µm) o con recubrimiento en polvo, con top de poliamida, acabado negro

5. PALA ESCRITORIO:







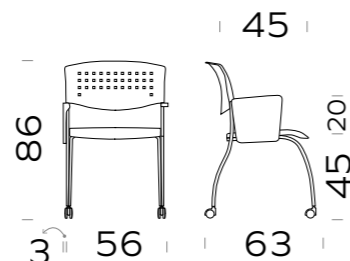
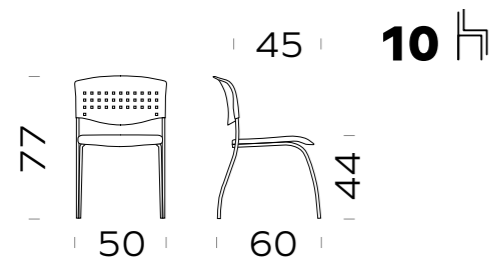

Acabado negro, con soporte en tubo de acero Ø 25mm, acabado con recubrimiento en polvo



ZIP

STRUTTURA IN METALLO, SEDILE E SCHIENALE IN POLIPROPILENE
 METAL STRUCTURE, POLYPROPYLENE BACK AND SEAT
 STRUCTURE EN MÉTAL, ASSISE ET DOSSIER EN POLYPROPYLENE
 METALSTRUKTUR, RÜCKENLEHNE UND SITZ AUS POLYPROPYLEN
 ESTRUCTURA EN METAL, ASIENTO Y RESPALDO EN POLYPROPILENE









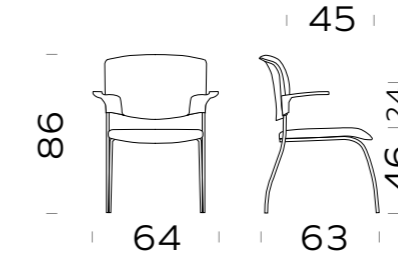
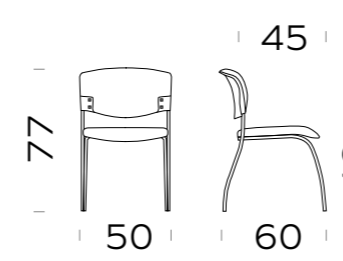















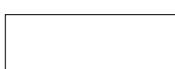



BASE BASE PIETEMENT GESTELL BASE	RUOTA/PIEDINO CASTOR/FEET ROULETTES/PATINS ROLLEN/GLEITER RUEDAS/PIES	STRUTTURA STRUCTURE STRUCTURE STRUKTUR ESTRUCTURA	CODICE CODE CODE ARTIKEL CÓDIGO	KG	PREZZO PRICE PRIX PREIS PRECIO	TESSUTI/FINITURE UPHOLSTERIES/FINISHING REVETEMENTS STOFFGRUPPE TAPICERÍAS			
					PLASTIC RAL	D	E	F	G
 4 gambe 4-legs 4 pieds 4-Fuß Gestell 4 patas	 tappi neri black plugs patins noirs schwarze Gleiter tapos negro	 Chromed	ZI0007	4,60	138				
		 RAL 9005 *	ZI0004	4,60	116				
 4 gambe 4-legs 4 pieds 4-Fuß Gestell 4 patas	 * d.50 mm autofrenanti gommate soft self-braking d.50mm d.50mm gommées autofreinante weiche gebremste D.50mm ruedas goma diam.50 autofreno	 Chromed	ZI0009	4,70	171				
		 RAL 9005 *	ZI0006	4,70	150				

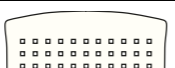













ZIP













STRUTTURA IN METALLO, SEDILE TAPPEZZATO SPESSE, SCHIENALE IN POLIPROPILENE O TAPPEZZATO
 METAL STRUCTURE, THICKER UPHOLSTERED SEAT, POLYPROPYLENE OR UPHOLSTERED SEAT
 STRUCTURE EN MÉTAL, ASSISE TAPISSÉE PLUS ÉPAIS, DOSSIER EN POLYPROPYLENE OU TAPISSÉE
 METALSTRUKTUR, DICKEN GEPOLSTERT SITZ, RÜCKENLEHNE AUS POLYPROPYLEN ODER GEPOLSTERT
 ESTRUCTURA EN METAL, ASIENTO AUMENT. TAPIZADO, RESPALDO EN POLYPROPILENE O TAPIZADO



BASE BASE PIETEMENT GESTELL BASE	RUOTA/PIEDINO CASTOR/FEET ROULETTES/PATINS ROLLEN/GLEITER RUEDAS/PIES	STRUTTURA STRUCTURE STRUCTURE STRUKTUR ESTRUCTURA	SCHIENALE BACKREST DOSSIER RÜCKENLEHNE RESPALDO	CODICE CODE CODE ARTIKEL CÓDIGO	KG	TESSUTI/FINITURE UPHOLSTERIES/FINISHING REVETEMENTS STOFFGRUPPE TAPICERÍAS			
						D	E	F	G
 4 gambe 4-legs 4 pieds 4-Fuß Gestell 4 patas	 tappi neri black plugs patins noirs schwarze Gleiter tapos negro	 Chromed	PLASTIC RAL	ZI0016	5,00	225	228	230	264
		 RAL 9005 *	UPHOLSTERED	ZI0034	5,80	273	282	293	355
 4 gambe 4-legs 4 pieds 4-Fuß Gestell 4 patas	 * d.50 mm autofrenanti gommate soft self-braking d.50mm d.50mm gommées autofreinante weiche gebremste D.50mm ruedas goma diam.50 autofreno	 Chromed	PLASTIC RAL	ZI0018	5,10	255	262	266	296
		 RAL 9005 *	UPHOLSTERED	ZI0036	5,80	307	315	325	386
 4 gambe 4-legs 4 pieds 4-Fuß Gestell 4 patas	 * d.50 mm autofrenanti gommate soft self-braking d.50mm d.50mm gommées autofreinante weiche gebremste D.50mm ruedas goma diam.50 autofreno	 RAL 9005 *	PLASTIC RAL	ZI0015	5,10	237	241	243	276
		 RAL 9005 *	UPHOLSTERED	ZI0033	5,80	286	296	303	367

* STRUCTURE RAL	PLASTIC RAL
DISPONIBILE ANCHE IN ALSO AVAILABLE ÉGALEMENT DISPONIBLE EN ERHÄLTICH AUCH IN TAMBIÉN DISPONIBLE EN  RAL 9016  RAL 1012  RAL 3012  RAL 6021  RAL 7032  RAL 7046	 RAL 9016  RAL 1012  RAL 6021  RAL 3012  RAL 3001  RAL 5009  RAL 7046  RAL 7032  RAL 9005

* STRUCTURE RAL	PLASTIC RAL
DISPONIBILE ANCHE IN ALSO AVAILABLE ÉGALEMENT DISPONIBLE EN ERHÄLTICH AUCH IN TAMBIÉN DISPONIBLE EN  RAL 9016  RAL 1012  RAL 3012  RAL 6021  RAL 7032  RAL 7046	 RAL 9016  RAL 1012  RAL 6021  RAL 3012  RAL 3001  RAL 5009  RAL 7046  RAL 7032  RAL 9005

OPZIONE OPTIONALS OPTIONS OPTIONEN OPCIONES	VARIANTE VARIANT VARIANTE VARIANTE VARIANTE	CODICE CODE CODE ARTIKEL CÓDIGO	KG	PREZZO PRICE PRIX PREIS PRECIO
 	 Chromed	XB044	1,60	74
	*  RAL 9005	XB045	1,60	61
 	Bracciolo fisso in poliammide <i>Polyamide fixed armrest</i> Accoudoir fixe en polyamide feste Polyamid Armlehne Reposabrazos fijo en polyamida	XB074	1,40	21
 	Tavoletta scrittoio destra <i>Right-hand writing tablet</i> Tablette écriteiro droite Schreibplatte rechts Pala escritorio derecha	XS003	1,30	63
ONLY WITH XB044 XB045				
 	Tavoletta scrittoio destra <i>Right-hand writing tablet</i> Tablette écriteiro droite Schreibplatte rechts Pala escritorio derecha	XS005	1,30	131
 	Carrello porta sedie <i>Chair trolley</i> Chariot porte-chaises Stapelstuhlwagen Carro para transporte de sillas	XA009	5,30	232

* DISPONIBILE ANCHE IN
 ALSO AVAILABLE
 ÉGALEMENT DISPONIBLE EN
 ERHÄLTLICH AUCH IN
 TAMBIÉN DISPONIBLE EN



RAL 9016



RAL 1012



RAL 3012



RAL 6021



RAL 7032



RAL 7046

* DISPONIBILE ANCHE CON
 ALSO AVAILABLE WITH
 ÉGALEMENT DISPONIBLE AVEC
 ERHÄLTLICH AUCH MIT
 TAMBIÉN DISPONIBLE CON



d.50 mm autofrenanti
 self-braking d.50mm
 d.50mm autofreinante
 gebremste D.50mm
 diam.50 autofreno

SAME PRICE

 MOVING

ECOCHAIR Visitor

idea: *Pietro Lovato*

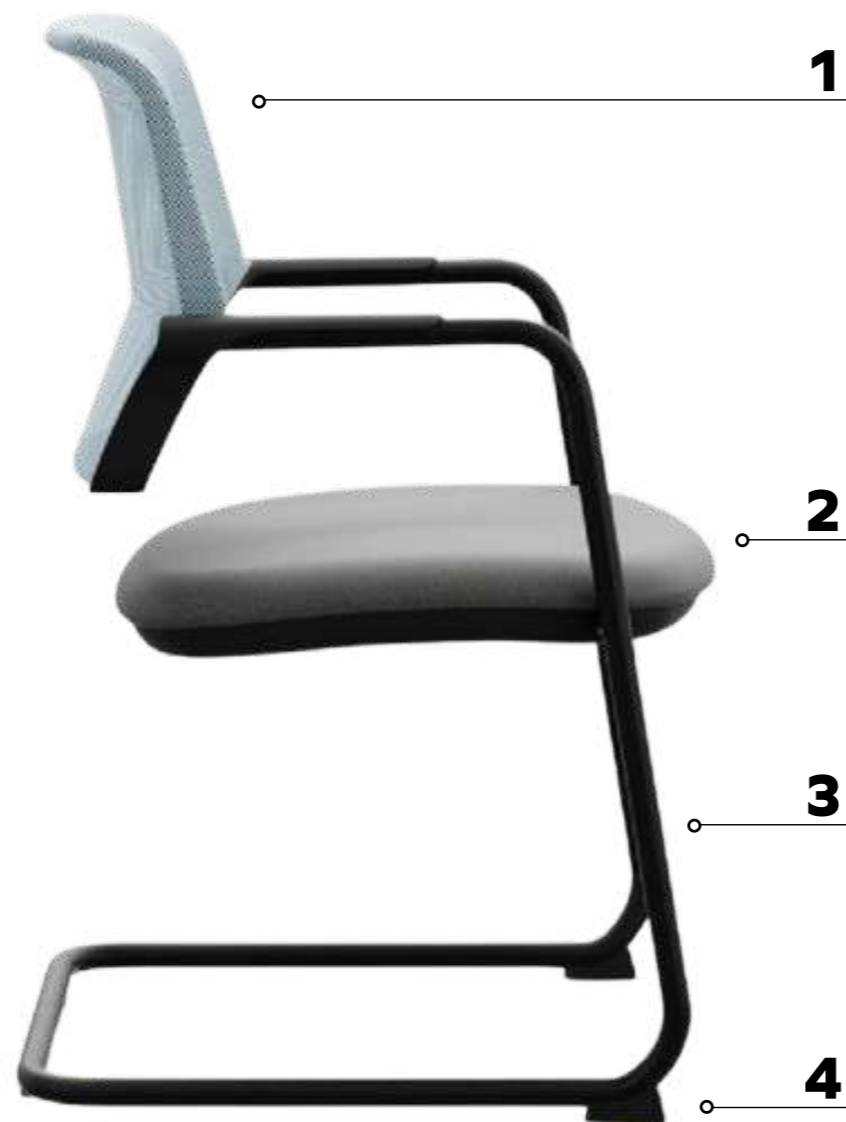

TECHNICAL INFORMATION

1. SCHIENALE:

Schienale in poliamide con carica di fibra di vetro, finitura nera, o schienale in tubo d'acciaio integrato alla base, rivestito in rete

2. SEDILE:

- Sedile in multistrato di legno con spugna, rivestito
- Sedile in polipropilene imbottito con spugna, rivestito

3. BASE:

- Base a slitta in tubo d'acciaio Ø 25mm, finitura cromata (15µm) o verniciata a polveri
- Base 4 gambe in tubo d'acciaio Ø 22mm, finitura cromata (15µm) o verniciata a polveri

4. RUOTE/PIEDINI:

- Ruote Ø 50mm, autofrenanti o autofrenanti e gommate, finitura nera
- Tappi antiribaltamento in poliamide, finitura nera
- Tappi in polipropilene, finitura nera

1. BACKREST:

Fiberglass reinforced polyamide backrest, black finish. Base integrated steel tube backrest, mesh upholstered

2. SEAT:

- Plywood seat, foam padded, upholstery
- Polypropylene seat, foam padded, upholstery

3. BASE:

- Cantilever base, Ø 25mm steel tube, chromed finish (15µm) or powder coated
- 4 Legs base, Ø 22 mm steel tube, chromed finish (15µm) or powder coated

4. CASTORS/FEET:

- Ø 50 mm self-braking castors, or soft self-bracking. Black finish
- Polyamide anti overturning plugs, black finish
- h.61 mm steel and polyamide glides, black finish
- Polypropylene plugs, black finish

1. DOSSIER:

Dossier en polyamide renforcé en fibre de verre, finition noir, en résille

2. ASSISE:

- Assise en multiplie de bois, rembourrée de mousse, tapissée
- Assise en polypropylène rembourrée de mousse, tapissée

3. PIÈTEMENT:

- Piètement luge en tube d'acier Ø 25mm, finition chromé (15µm) ou verni époxy
- Piètement 4 pieds en tube d'acier Ø 22mm, finition chromé (15µm) ou verni époxy

4. ROULETTES/PATINS:

- Roulettes Ø 50mm, autofreinantes ou autofreinantes et gommées, finition noir
- Tampons anti renversement en polyamide noir
- Patin en acier et polyamide, h.61mm, finition noir
- Tampons en polypropylène, finition noir

1. RÜCKENLEHNE:

Schwarze glasfaserverstärktpolyamid Netz Rückenlehne, mit Integriert lumbalstütze

2. SITZ:

- Holzstiz, ausgepolstert mit Polyurethanschaum, mit Bezug
- Polypropylen Sitz, ausgepolstert mit Polyurethanschaum, mit Bezug

3. GESTELL:

- Freischwinger Gestell, Ø 25mm Stahlrohr verchromt (15µm) oder pulverbeschichtet
- 4-Fuß Gestell, Ø 22 mm Stahlrohr verchromt (15µm) oder pulverbeschichtet

4. ROLLEN/GLEITER:

- Ø 50 mm gebremste, oder weiche gebremste Rollen, schwarz
- Anti Unkippleiter aus Polyamid, schwarz
- h.61mm Stahl und schwarze Polyamid Gleiter
- Polyamid gleiter, schwarz

1. RESPALDO:

Respaldo de poliamida cargada en fibra de vidrio, acabado negro o parte posterior de tubo de acero integrada en la base, malla

2. ASIENTO:

- Asiento multicapa de madera con espuma, tapizado
- Asiento de polipropileno acolchado con espuma, tapizado

3. BASE:

- Base de trineo en tubo de acero de Ø 25 mm, acabado cromado (15µm) o con recubrimiento en polvo
- Base de 4 patas en tubo de acero de Ø 22 mm, acabado cromado (15µm) o con recubrimiento en polvo

4. RUEDAS / PIES:

- Ø 50 mm, blandas o autofrenado y blandas, acabado negro
- Tapones antivuelco en poliamida, acabado negro
- Tapones de polipropileno, acabado negro







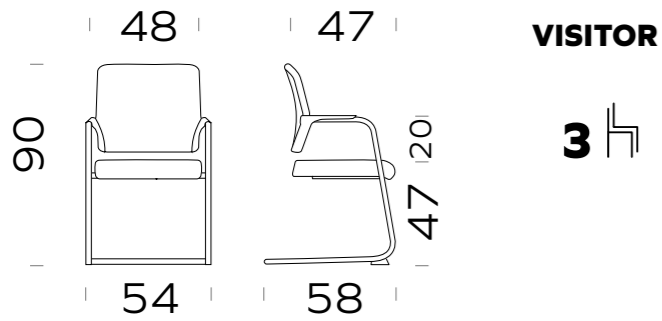

ID 1111209612

ECOCHAIR

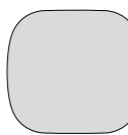
SCHIENALE MEDIO IN RETE, STRUTTURA IN METALLO, SEDILE IMBOTTITO
 MEDIUM MESH BACKREST, METAL STRUCTURE, UPHOLSTERED SEAT
 MOYEN DOSSIER EN RESILLE, STRUCTURE EN METAL, ASSISE REMBOURRÉ
 NETZ MITTLERE RÜCKENLEHNE, METALGESTELL, GEPOLSTERT SITZ
 MEDIO RESPALDO EN MALLA, ESTRUCTURA EN METAL, ASIENTO TAPIZADO

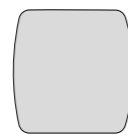

BASE BASE PIETEMET GESTELL BASE	RUOTA/PIEDINO CASTOR/FEET ROULETTES/PATINS ROLLEN/GLEITER RUEDAS/PIES	SOTTOFAMIGLIA SUBFAMILY SOUS-FAMILLE VARIANTE SUBFAMILIA	STRUTTURA STRUCTURE STRUCTURE STRUKTUR ESTRUCTURA	RETE MESH MAILLE NETZ MALLA	CODICE CODE ARTIKEL CÓDIGO	KG	TESSUTI/FINITURE UPHOLSTERIES/FINISHING REVETEMENTS STOFFGRUPPE TAPICERÍAS			
							D	E	F	G
				M-N	EC0012	9,30	384	388	393	433
				M-N	EC0010	9,30	341	351	355	393
				M-N	EC0006	8,70	397	403	410	447
				M-N	EC0004	8,70	360	365	371	410

* DISPONIBILE ANCHE IN
 ALSO AVAILABLE
 ÉGALEMENT DISPONIBLE EN
 ERHÄLTICH AUCH IN
 TAMBIÉN DISPONIBLE EN



RAL 9016



RAL 1012



RAL 3012



RAL 6021



RAL 7032







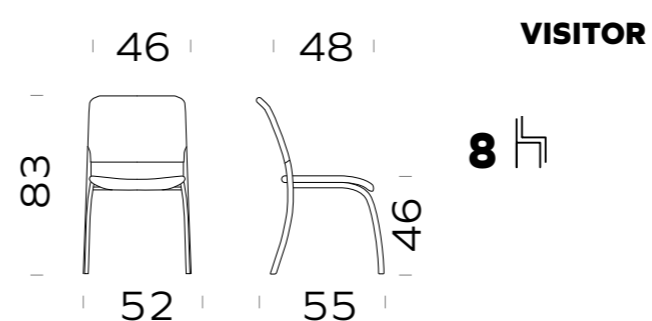

RAL 7046

ECOCHAIR

SCHIENALE MEDIO IN RETE, STRUTTURA IN METALLO, SEDILE IMBOTTITO
 MEDIUM MESH BACKREST, METAL STRUCTURE, UPHOLSTERED SEAT
 MOYEN DOSSIER EN RESILLE, STRUCTURE EN METAL, ASSISE REMBOURRÉ
 NETZ MITTLERE RÜCKENLEHNE, METALGESTELL, GEPOLSTERT SITZ
 MEDIO RESPALDO EN MALLA, ESTRUCTURA EN METAL, ASIENTO TAPIZADO



BASE BASE PIETEMET GESTELL BASE	RUOTA/PIEDINO CASTOR/FEET ROULETTES/PATINS ROLLEN/GLEITER RUEDAS/PIES	STRUTTURA STRUCTURE STRUCTURE STRUKTUR ESTRUCTURA	RETE MESH MAILLE NETZ MALLA	CODICE CODE ARTIKEL CÓDIGO	KG	TESSUTI/FINITURE UPHOLSTERIES/FINISHING REVETEMENTS STOFFGRUPPE TAPICERÍAS			
						D	E	F	G
			M-N	EC0049	5,40	283	294	300	336
				M-N	EC0046	5,40	247	253	257
			M-N	EC0051	5,40	312	318	326	362
				M-N	EC0048	5,40	273	279	282

* DISPONIBILE ANCHE IN
 ALSO AVAILABLE
 ÉGALEMENT DISPONIBLE EN
 ERHÄLTICH AUCH IN
 TAMBIÉN DISPONIBLE EN



RAL 9016



RAL 1012



RAL 3012



RAL 6021



RAL 7032



RAL 7046

* DISPONIBILE ANCHE CON
 ALSO AVAILABLE WITH
 ÉGALEMENT DISPONIBLE AVEC
 ERHÄLTICH AUCH MIT
 TAMBIÉN DISPONIBLE CON











d.50 mm autofrenanti
 self-braking d.50mm
 d.50mm autofreinante
 gebremste D.50mm
 diam.50 autofreno

SAME PRICE

ECOCHAIR

OPTIONALS

VISITOR

OPZIONE OPTIONALS OPTIONS OPTIONEN OPCIONES	VARIANTE VARIANT VARIANTE VARIANTE VARIANTE	CODICE CODE CODE ARTIKEL CODIGO	KG	PREZZO PRICE PRIX PREIS PRECIO
	 Chromed	XB044	1,60	74
	*  RAL 9005	XB045	1,60	61
4   ONLY WITH XB044 XB045	Tavoletta scrittoio destra <i>Right-hand writing tablet</i> Tablette écriteiro droite <i>Schreibplatte rechts</i> Pala escritorio derecha	XS003	1,30	63
3  	Tavoletta scrittoio destra <i>Right-hand writing tablet</i> Tablette écriteiro droite <i>Schreibplatte rechts</i> Pala escritorio derecha	XS005	1,30	131
 	Carrello porta sedie <i>Chair trolley</i> Chariot porte-chaises <i>Stapelstuhlwagen</i> Carro para transporte de sillas	XA009	5,30	232

* DISPONIBILE ANCHE IN
ALSO AVAILABLE
ÉGALEMENT DISPONIBLE EN
ERHÄLTlich AUCh IN
TAMBIÉN DISPONIBLE EN

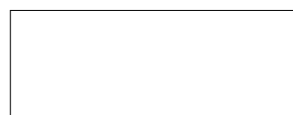

RAL 9016



RAL 1012



RAL 3012



RAL 6021



RAL 7032



RAL 7046

 MOVING

TECHNICAL INFORMATION

1. SCHIENALE:

Schienale in poliamide con carica di fibra di vetro

2. SEDILE:

Sedile in polipropilene imbottito con spugna, rivestito

3. BASE:

- Base a slitta in tubo d'acciaio Ø 25mm, finitura cromata (15µm) o verniciata a polveri
- Base 4 gambe in tubo d'acciaio Ø 25mm, finitura cromata (15µm) o verniciata a polveri

1. BACKREST

Fiberglass reinforced polyamide backrest, black finish

2. SEAT:

Polypropylene seat, foam padded, upholstery

3. BASE:

- Cantilever base, Ø 25mm steel tube, chromed finish (15µm) or powder coated
- 4 Legs base, Ø 25 mm steel tube, chromed finish (15µm) or powder coated

1. DOSSIER:

Dossier en polyamide renforcé en fibre de verre

2. ASSISE:

Assise en polypropylène rembourrée de mousse, tapissée

3. PIÈTEMENT:

- Piètement luge en tube d'acier Ø 25mm, finition chromé (15µm) ou verni époxy
- Piètement 4 pieds en tube d'acier Ø 25mm, finition chromé (15µm) ou verni époxy

1. RÜCKENLEHNE:

Glasfaserverstärktpolyamid Netz Rückenlehne

2. SITZ:

Polypropylen Sitz, ausgepolstert mit Polyurethanschaum, mit Bezug

3. GESTELL:

- Freischwinger Gestell, Ø 25mm Stahlrohr verchromt (15µm) oder pulverbeschichtet
- 4-Fuß Gestell, Ø 25 mm Stahlrohr verchromt (15µm) oder pulverbeschichtet

1. RESPALDO:

Respaldo de poliamida cargado de fibra de vidrio

2. ASIENTO:

Asiento de polipropileno acolchado con espuma, tapizado

3. BASE:

- Base de trineo en tubo de acero de Ø 25 mm, acabado cromado (15µm) o pintada a polvo
- Base de 4 patas en tubo de acero de Ø 25 mm, acabado cromado (15µm) o pintada a polvo

FLEXA Visitor

idea: *Pietro Lovato*



ID 1111210200

FLEXA VISITOR

SCHIENALE MEDIO IN COPOLIMERO, STRUTTURA IN METALLO, SEDILE IMBOTTITO
 MEDIUM COPOLIMER BACKREST, METAL STRUCTURE, UPHOLSTERED SEAT
 MOYEN DOSSIER EN COPOLYMÈRE, STRUCTURE EN MÉTAL, ASSISE REMBOURRÉ
 POLYP-COPOLYMER RÜCKENLEHNE, METALSTRUKTUR, GEPOLSTERT SITZ
 CONCHA EN COPOLIMERO, ESTRUCTURA EN METAL, ASIENTO TAPIZADO

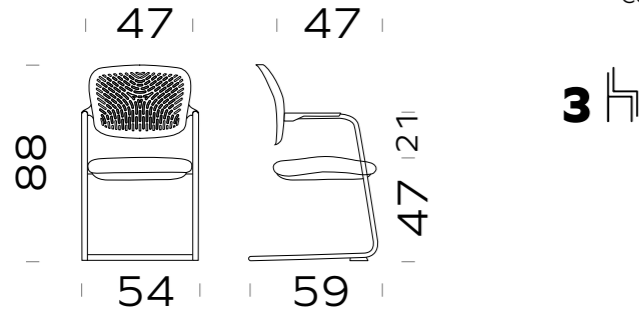

BASE BASE PIEITEMENT GESTELL BASE	RUOTA/PIEDINO CASTOR/FEET ROULETTES/PATINS ROLLEN/GLEITER RUEDAS/PIES	STRUTTURA STRUCTURE STRUKTUR ESTRUCTURA	CODICE CODE ARTIKEL CÓDIGO	KG	SCHIENALE BACKREST DOSSIER RÜCKENLEHNE RESPALDO	TESSUTI/FINITURE UPHOLSTERIES/FINISHING REVETEMENTS STOFFGRUPPE TAPICERIAS			
						D	E	F	G
			FL0019	7,40	BACKREST RAL	221	230	234	270
			FL0016	7,40	BACKREST RAL	182	185	190	223

*slitta con braccioli cantilever with arms
luge avec accoudoires
Freischwinger Gestell mit Armlehnen
patin con brazos*

*neri con feltrini
black with felts
noirs avec feutres
schwarze Filzgleiter
negro con filetro*

OPZIONE OPTIONALS OPTIONS OPTIONEN OPCIONES	VARIANTE VARIANT VARIANTE VARIANTE	CODICE CODE ARTIKEL CÓDIGO	KG	PREZZO PRICE PRIX PREIS PRECIO	TESSUTI/FINITURE UPHOLSTERIES/FINISHING REVETEMENTS STOFFGRUPPE TAPICERIAS			
					D	E	F	G
	BACKREST CUSHION	XC019	0,90		40	44	48	71
	Carrello porta sedie Chair trolley Chariot porte-chaïses Stapelstuhlwagen Carro para transporte de sillas ONLY FOR FL0019 FL0016	XA009	5,30	232				

STRUCTURE RAL	BACKREST RAL		
* DISPONIBILE ANCHE IN ALSO AVAILABLE ÉGALEMENT DISPONIBLE EN ERHÄLTICH AUCH IN TAMBIÉN DISPONIBLE EN			
RAL 9016	RAL 1012	RAL 3012	
RAL 6021	RAL 7032	RAL 7046	RAL 9005

FLEXA VISITOR

SCHIENALE MEDIO IN COPOLIMERO, STRUTTURA IN METALLO, SEDILE IMBOTTITO
 MEDIUM COPOLIMER BACKREST, METAL STRUCTURE, UPHOLSTERED SEAT
 MOYEN DOSSIER EN COPOLYMÈRE, STRUCTURE EN MÉTAL, ASSISE REMBOURRÉ
 POLYP-COPOLYMER RÜCKENLEHNE, METALSTRUKTUR, GEPOLSTERT SITZ
 CONCHA EN COPOLIMERO, ESTRUCTURA EN METAL, ASIENTO TAPIZADO

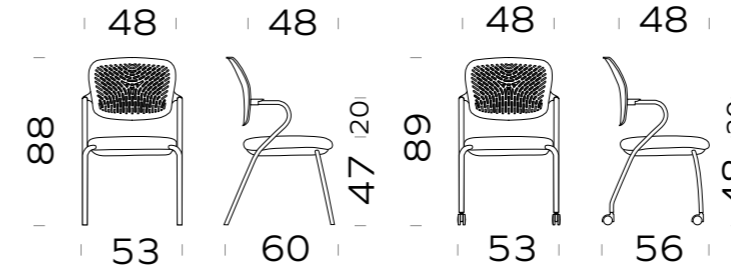

BASE BASE PIEITEMENT GESTELL BASE	RUOTA/PIEDINO CASTOR/FEET ROULETTES/PATINS ROLLEN/GLEITER RUEDAS/PIES	STRUTTURA STRUCTURE STRUKTUR ESTRUCTURA	CODICE CODE ARTIKEL CÓDIGO	KG	SCHIENALE BACKREST DOSSIER RÜCKENLEHNE RESPALDO	TESSUTI/FINITURE UPHOLSTERIES/FINISHING REVETEMENTS STOFFGRUPPE TAPICERIAS			
						D	E	F	G
			FL0042	6,90	BACKREST RAL	194	204	210	247
			FL0041	6,90	BACKREST RAL	153	165	171	210
			FL0035	7,10	BACKREST RAL	207	218	223	261
			FL0037	7,10	BACKREST RAL	169	178	185	223

STRUCTURE RAL	BACKREST RAL		
* DISPONIBILE ANCHE IN ALSO AVAILABLE ÉGALEMENT DISPONIBLE EN ERHÄLTICH AUCH IN TAMBIÉN DISPONIBLE EN			
RAL 9016	RAL 1012	RAL 3012	
RAL 6021	RAL 7032	RAL 7046	RAL 9005

* DISPONIBILE ANCHE CON
ALSO AVAILABLE WITH
ÉGALEMENT DISPONIBLE AVEC
ERHÄLTICH AUCH MIT
TAMBIÉN DISPONIBLE CON

SAME PRICE

DAMA Visitor

idea: *Pietro Lovato*

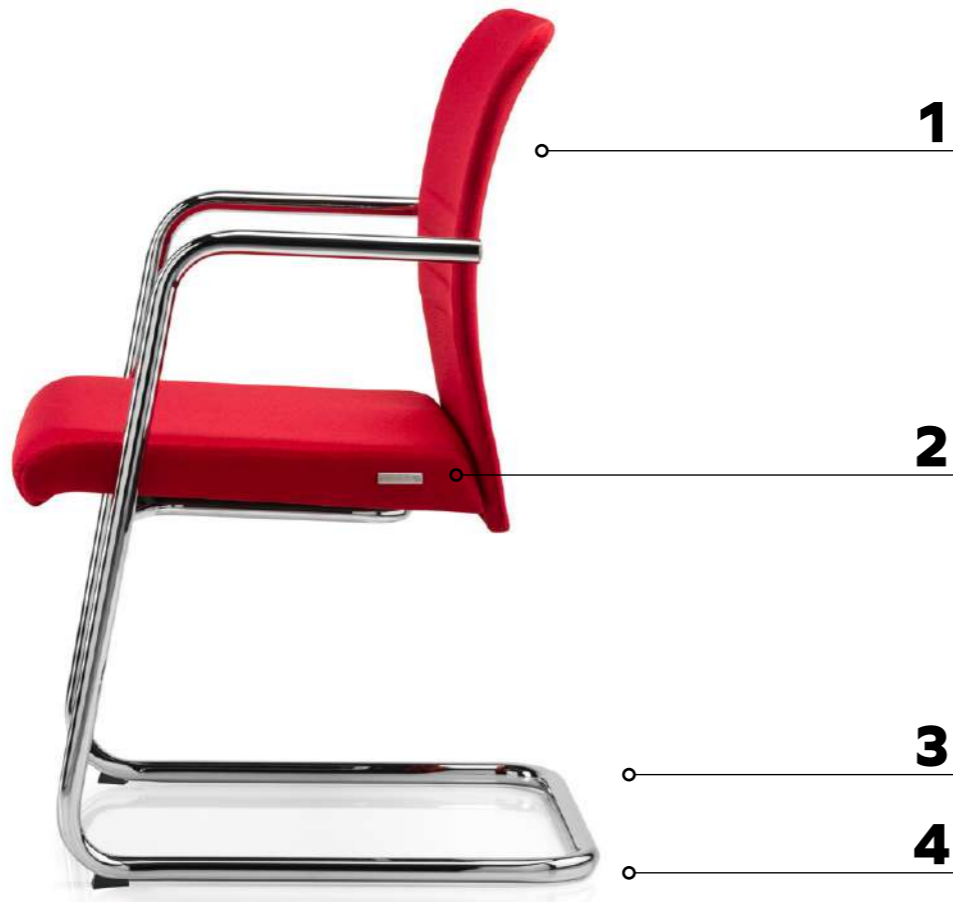

TECHNICAL INFORMATION

1. SCHIENALE:

Schienale in tubo ovale d'acciaio, Ø 20mm, finitura verniciata a polvere, in rete o rivestito

2. SEDILE:

Sedile in multistrato di legno con spugna, rivestito

3. BASE:

• Base a slitta in tubo d'acciaio Ø 25mm, finitura cromata (15µm)

4. PIEDINI:

• Tappi antiribaltamento in poliamide, finitura nera

1. BACKREST:

Oval steel tube Ø 20mm, backrest, powder coated, mesh or upholstered

2. SEAT:

Plywood seat, foam padded, upholstery

3. BASE:

• Cantilever base, Ø 25mm steel tube, chromed finish (15µm)

4. FEET:

• Polyamide anti overturning plugs, black finish

1. DOSSIER:

Dossier en tube d'acier ovale, Ø 20mm, finition verni époxy, en résille ou tapissé

2. ASSISE:

Assise en multiplie de bois, rembourrée de mousse, tapissée

3. PIÈTEMENT:

• Piètement luge en tube d'acier Ø 25mm, finition chromé (15µm)

4. PATINS:

• Patins anti renversement en polyamide, finition noir

1. RÜCKENLEHNE:

Rückenlehne aus Stahlrohr, Ø 20mm, mit Netzbezug oder gepolstert

2. SITZ:

Sperrholzsitz gepolstert mit Schaumstoff und Bezug

3. GESTELL:

• Freischwinger Gestell, Ø 25mm Stahlrohr verchromt (15µm)

4. GLEITER:

• Anti Unkippleiter aus Polyamid, schwarz

1. RESPALDO:

Respaldo de tubo de acero ovalado, Ø 20mm, acabado pintado en polvo, con malla o tapizado

2. ASIENTO:

Asiento multicapa de madera con espuma, tapizado

3. BASE:

• Base de trineo en tubo de acero de Ø 25 mm, acabado cromado (15µm)

4. PIES:

• Tapones antivuelco en poliamida, acabado negro.

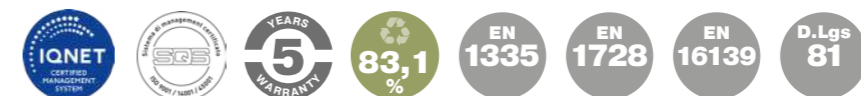

DAMA

IMBOTTITA, STRUTTURA IN METALLO, SCHIENALE MEDIO
 UPHOLSTERED, METAL STRUCTURE, MEDIUM BACKREST
 REMBOURRÉ, STRUCTURE EN METAL, MOYEN DOSSIER
 GEPOLSTERT, METALSTRUKTUR, MITTLERE RÜCKENLEHNE
 TAPIZADA, ESTRUCTURA EN METAL, MEDIO RESPALDO

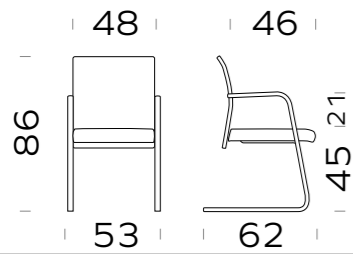

VISITOR



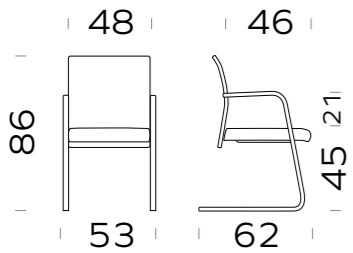

BASE BASE PIETEMENT GESTELL BASE	RUOTA/PIEDINO CASTOR/FEET ROULETTES/PATINS ROLLEN/GLEITER RUEDAS/PIES	STRUTTURA STRUCTURE STRUCTURE STRUKTUR ESTRUCTURA	CODICE CODE CODE ARTIKEL CÓDIGO	KG	TESSUTI/FINITURE UPHOLSTERIES/FINISHING REVETEMENTS STOFFGRUPPE TAPICERÍAS				
					D	E	F	G	H
 slitta con braccioli cantilever with arms luge avec accoudoiries Freischwinger mit Armlehnen patin con brazos	 neri con feltrini black with felts noirs avec feutres schwarze Filzgleiter negro con fieltro	 Chromed	DM0124	10,80	561	570	608	671	788
		 RAL 9005 *	DM0308	10,80	518	527	565	628	745

DAMA R

SCHIENALE MEDIO IN RETE, STRUTTURA IN METALLO, SEDILE IMBOTTITO
 MEDIUM MESH BACKREST, METAL STRUCTURE, UPHOLSTERED SEAT
 MOYEN DOSSIER EN RESILLE, STRUCTURE EN METAL, ASSISE REMBOURRÉ
 MITTLERE NETZ RÜCKENLEHNE, METALSTRUKTUR, GEPOLSTERT SITZ
 MEDIO RESPALDO EN MALLA, ESTRUCTURA EN METAL, ASIENTO TAPIZADO



VISITOR

BASE BASE PIETEMENT GESTELL BASE	RUOTA/PIEDINO CASTOR/FEET ROULETTES/PATINS ROLLEN/GLEITER RUEDAS/PIES	STRUTTURA STRUCTURE STRUCTURE STRUKTUR ESTRUCTURA	CODICE CODE CODE ARTIKEL CÓDIGO	KG	RETE MESH RÉSILLE NETZ MALLA	TESSUTI/FINITURE UPHOLSTERIES/FINISHING REVETEMENTS STOFFGRUPPE TAPICERÍAS			
						D	E	F	G
 slitta con braccioli cantilever with arms luge avec accoudoiries Freischwinger mit Armlehnen patin con brazos	 neri con feltrini black with felts noirs avec feutres schwarze Filzgleiter negro con fieltro	 Chromed	DM0127	10,80	M-N	470	472	486	518
		 RAL 9005 *	DM0332	10,80	M-N	427	429	443	475

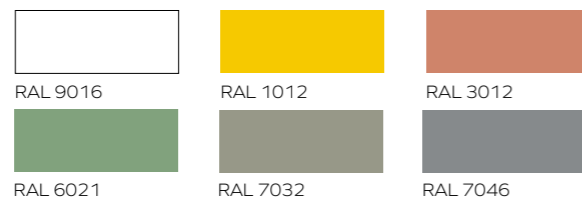

* DISPONIBILE ANCHE IN
 ALSO AVAILABLE
 ÉGALEMENT DISPONIBLE EN
 ERHÄLTlich AUCh IN
 TAMBIÉN DISPONIBLE EN



DAMA

OPTIONALS

VISITOR

OPZIONE OPTIONALS OPTIONS OPTIONEN OPCIONES	VARIANTE VARIANT VARIANTE VARIANTE VARIANTE	CODICE CODE CODE ARTIKEL CÓDIGO	KG	PREZZO PRICE PRIX PREIS PRECIO	TESSUTI/FINITURE UPHOLSTERIES/FINISHING REVETEMENTS STOFFGRUPPE TAPICERÍAS			
					D	E	F	G
	 RAL 9005 *	XH009	0,20	9				
	UPHOLSTERED	XH010	0,10		26	26	26	26

* DISPONIBILE ANCHE IN
 ALSO AVAILABLE
 ÉGALEMENT DISPONIBLE EN
 ERHÄLTlich AUCh IN
 TAMBIÉN DISPONIBLE EN

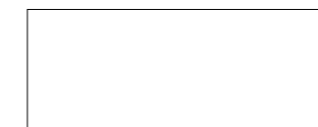

RAL 9016



RAL 1012



RAL 3012



RAL 6021



RAL 7032



RAL 7046

PRETTY

design: Giovanni Amalfitano

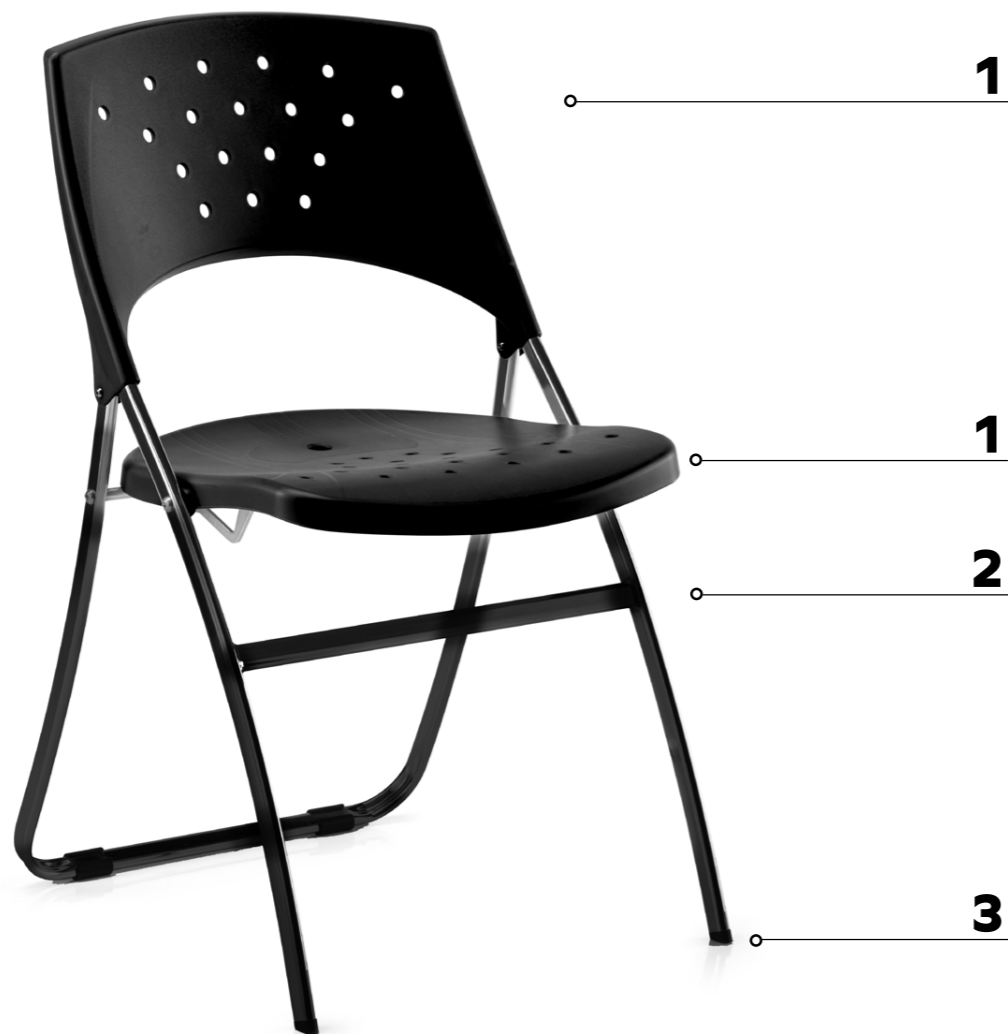

1. SCHIENALE E SEDILE:
Schienale e sedile in polipropilene, con imbottitura ignifuga rivestita in finta pelle.
2. BASE:
Base 4 gambe in tubo ovale d'acciaio, 25x12mm, finitura verniciata a polveri.
3. PIEDINI:
Tappi in polipropilene, finitura nera.
4. AGGANCIABILITÀ:
Sistema di agganciabilità standard con due punti di ancoraggio in metallo.

1. BACKREST AND SEAT:
Seat and backrest in polypropylene with fire-resistant padding upholstered in synthetic leather.
2. BASE:
4 legs base, 25x12mm oval steel tube, powder coated finish.
3. FEET:
Polypropylene plugs, black finish.
4. LINKABILITY:
Standard linking system with two metal anchoring points.

1. DOSSIER ET ASSISE:
Dossier et assise en polypropylène, avec rembourrage ignifuge revêtu de cuir synthétique.
2. PIÈTEMENT:
Piètement 4 pieds en tube ovale d'acier, 25x12mm, finition verni époxy.
3. PATINS:
Tampons en polypropylène, finition no.
4. ACCROCHABILITÉ:
Système d'accrochage standard avec deux points d'ancrage en métal.

1. RÜCKENLEHNE UND SITZ:
Polypropylen Sitz und Rückenlehne, mit schwer entflammbarer Polsterung, bezogen mit Kunstleder.
2. GESTELL:
4-Fuß Gestell, 25x12mm ovales Stahlrohr pulverbeschichtet.
3. GLEITER:
Polyamid gleiter, schwarz.
4. VERBINDUNGSMÖGLICHKEIT:
Standard-Kopplungssystem mit zwei Metallbefestigungspunkten.

1. RESPALDO Y ASIENTO:
Respaldo y asiento en polipropileno, con acolchado ignifugo tapizado en piel sintética.
2. BASE:
Base de 4 patas en tubo de acero ovalado, 25x12 mm, acabado con recubrimiento en polvo.
3. PIES:
Tapones de polipropileno, acabado negro.
4. CONECTIVIDAD:
Sistema de unión estándar con dos puntos de anclaje metálicos.

TECHNICAL INFORMATION



PRETTY

SEDIA PIEGHEVOLE CON BLOCCO DI SICUREZZA CON SEDILE E SCHIENALE IN POLIPROPILENE
 VISITEUR, SEAT AND BACKREST IN POLYPROPYLENE, FOLDABLE SAFE BLOCK
 VISITEUR, ASSISE ET DOSSIER EN POLYPROP., PLIANTE, AVEC CROCHET DE SÉCURITÉ
 KLAPPSTUHL, SITZ UND RÜCKENLEHNE AUS POLYP., MIT KLAPPSICHERUNG
 FIJA, ASIENTO Y RESPALDO IN POLYPPROPILENE, PLEGABLE, BLOQUE DE SEGURIDAD

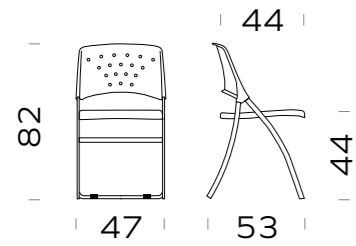

10



BASE BASE PIETEMET GESTELL BASE	RUOTA/PIEDINO CASTOR/FEET ROULETTES/PATINS ROLLEN/GLEITER RUEDAS/PIES	STRUTTURA STRUCTURE STRUCTURE STRUKTUR ESTRUCTURA	CODICE CODE CODE ARTIKEL CÓDIGO	KG	PREZZO PRICE PRIX PREIS PRECIO
					PLASTIC RAL
 gambe in ferro <i>iron legs</i> pieds en métal <i>Fuß aus Eisen</i> patas en metal	 tappi <i>plugs</i> patins <i>Gleiter</i> tapos	 Chromed	PR0003	4,70	144
		 RAL 9005 *	PR0002	4,70	141

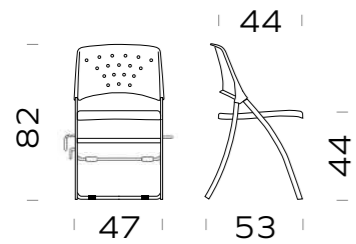

BASE BASE PIETEMET GESTELL BASE	RUOTA/PIEDINO CASTOR/FEET ROULETTES/PATINS ROLLEN/GLEITER RUEDAS/PIES	STRUTTURA STRUCTURE STRUCTURE STRUKTUR ESTRUCTURA	CODICE CODE CODE ARTIKEL CÓDIGO	KG	PREZZO PRICE PRIX PREIS PRECIO
					PLASTIC RAL
 gambe in ferro agganciabili <i>attachable iron legs</i> pieds en métal amovibles <i>Ansteckbare Fuß aus Eisen</i> patas en metal acoplables	 tappi <i>plugs</i> patins <i>Gleiter</i> tapos	 RAL 9005	PR0008	4,70	191

* STRUCTURE RAL	PLASTIC RAL
DISPONIBILE ANCHE IN ALSO AVAILABLE ÉGALEMENT DISPONIBLE EN ERHÄLTICH AUCH IN TAMBIÉN DISPONIBLE EN	
 RAL 9016	 RAL 9016 RAL 9005
 RAL 3012	 RAL 3012 RAL 3001 RAL 6021
 RAL 6021	 RAL 5009 RAL 7046
 RAL 7046	

PRETTY

OPTIONALS

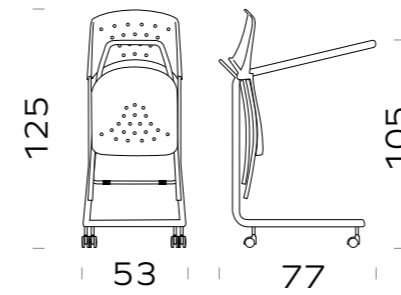

OPZIONE OPTIONALS OPTIONS OPTIONEN OPCIONES	VARIANTE VARIANT VARIANTE VARIANTE VARIANTE	CODICE CODE CODE ARTIKEL CÓDIGO	KG	PREZZO PRICE PRIX PREIS PRECIO
 10	Carrello porta sedie <i>Chair trolley</i> Chariot porte-chaises <i>Stapelstuhlwagen</i> Carro para transporte de sillas	XA010	5,30	186

TECHNICAL INFORMATION

1. SCHIENALE E SEDILE:

Schienale e sedile in polipropilene, con imbottitura ignifuga rivestita in finta pelle.
2. BASE:
 Base 4 gambe in tubo ovale d'acciaio, 25x12mm, finitura verniciata a polveri.

3. PIEDINI:
 Tappi in polipropilene, finitura nera.

4. AGGANCIABILITÀ:
 Sistema di agganciabilità standard con due punti di ancoraggio in metallo.

1. BACKREST AND SEAT:

Seat and backrest in polypropylene with fire-resistant padding upholstered in synthetic leather.

2. BASE:
 4 legs base, 25x12mm oval steel tube, powder coated finish.

3. FEET:
 Polypropylene plugs, black finish.

4. LINKABILITY:
 Standard linking system with two metal anchoring points.

1. DOSSIER ET ASSISE:

Dossier et assise en polypropylène, avec rembourrage ignifuge revêtu de cuir synthétique.

2. PIÈTEMENT:
 Piètement 4 pieds en tube ovale d'acier, 25x12mm, finition verni époxy.

3. PATINS:
 Tampons en polypropylène, finition no.

4. ACCROCHABILITÉ:
 Système d'accrochage standard avec deux points d'ancrage en métal.

1. RÜCKENLEHNE UND SITZ:

Polypropylen Sitz und Rückenlehne, mit schwer entflammbarer Polsterung, bezogen mit Kunstleder.

2. GESTELL:
 4-Fuß Gestell, 25x12mm ovales Stahlrohr pulverbeschichtet.

3. GLEITER:
 Polyamid gleiter, schwarz.

4. VERBINDUNGSMÖGLICHKEIT:
 Standard-Kopplungssystem mit zwei Metallbefestigungspunkten.

1. RESPALDO Y ASIENTO:

Respaldo y asiento en polipropileno, con acolchado ignífugo tapizado en piel sintética.

2. BASE:
 Base de 4 patas en tubo de acero ovalado, 25x12 mm, acabado con recubrimiento en polvo.

3. PIES:
 Tapones de polipropileno, acabado negro.

4. CONECTIVIDAD:
 Sistema de unión estándar con dos puntos de anclaje metálicos.

PRETTY SPORT

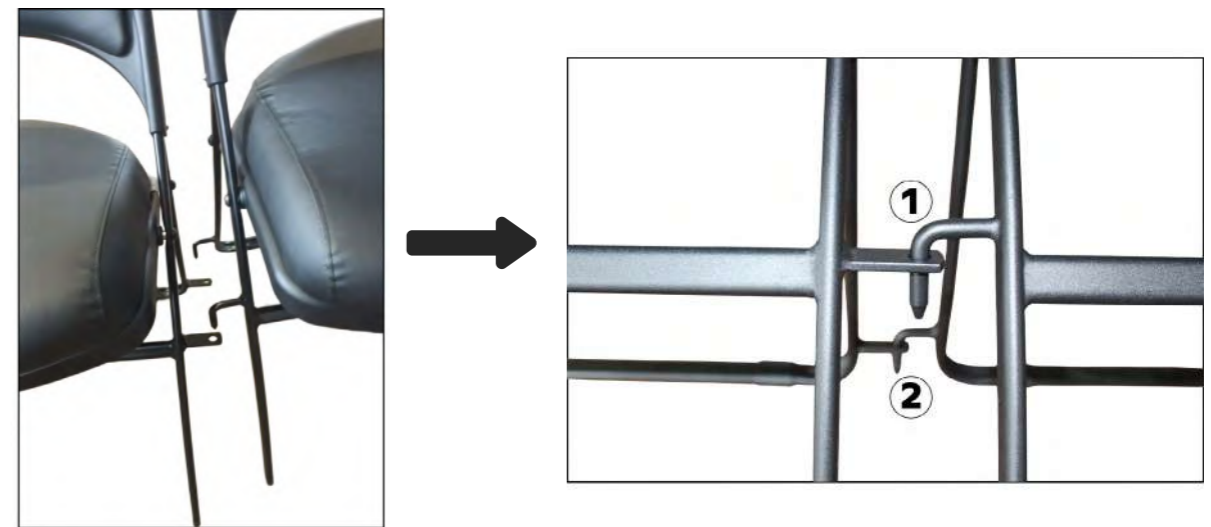

design: Giovanni Amalfitano

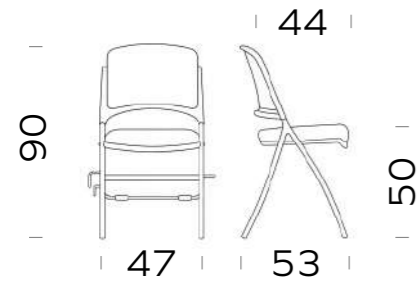

PRETTY SPORT

SEDIA PIEGHEVOLE CON BLOCCO DI SICUREZZA CON SEDILE E SCHIENALE IMBOTTITO
 UPHOLSTERED SEAT AND BACKREST, FOLDABLE SAFE BLOCK
 ASSISE ET DOSSIER TAPISSÉS., PLIANTE, AVEC CROCHET DE SÉCURITÉ
 KLAPPSTUHL, SITZ UND RÜCKENLEHNE GEPOLSTERT, MIT KLAPPSICHERUNG
 ASIENTO Y RESPALDO TAPIZADOS, PLEGABLE, BLOQUE DE SEGURIDAD



BASE BASE PIETEMENT GESTELL BASE	RUOTA/PIEDINO CASTOR/FEET ROULETTES/PATINS ROLLEN/GLEITER RUEDAS/PIES	STRUTTURA STRUCTURE STRUCTURE STRUKTUR ESTRUCTURA	CODICE CODE CODE ARTIKEL CÓDIGO	KG	TESSUTI/FINITURE UPHOLSTERIES/FINISHING REVETEMENTS STOFFGRUPPE TAPICERÍAS
					D
 <p>gambe in ferro agganciabili attachable iron legs pieds en métal amovibles Ansteckbare Fuß aus Eisen patas en metal acoplables</p>	 <p>tappi plugs patins Gleiter tapos</p>	 <p>RAL 9005 *</p>	PR0005	4,70	540

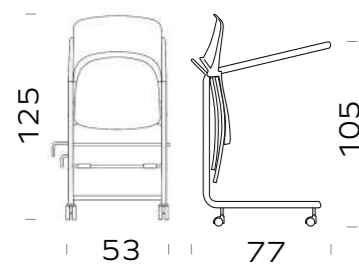

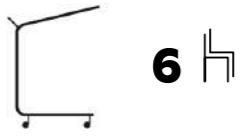
OPZIONE OPTIONALS OPTIONS OPTIONEN OPCIONES	VARIANTE VARIANT VARIANTE VARIANTE VARIANTE	CODICE CODE CODE ARTIKEL CÓDIGO	KG	PREZZO PRICE PRIX PREIS PRECIO
 <p>6</p>	<p>Carrello porta sedie Chair trolley Chariot porte-chaises Stapelstuhlwagen Carro para transporte de sillas</p>	XA010	5,30	186

 MOVING

PILATUS

idea: *Pietro Lovato*



TECHNICAL INFORMATION

1. SCHIENALE :

Struttura in metallo, con imbottitura in poliuretano schiumato a freddo, rivestito.

2. SEDILE :

Sedile in multistrato di legno imbottito con spugna e rivestito

3. MECCANISMO :

Comando elevazione a gas

4. GAS :

- Regolabile in altezza, finitura cromata
- Regolabile in altezza, finitura nera

5. BASE :

- Base 5 razze in alluminio, Ø 670mm, finitura lucida
- Base 5 razze in poliammide, Ø 640mm, finitura nera

6. RUOTE/PIEDINI :

- Ruote Ø 50mm autofrenanti o autofrenanti e gommate, finitura nera
- Piedini in poliammide, h. 61mm, finitura nera
- Ruote Ø 50mm, autobloccanti gommate, finitura nera.

1. BACKREST :

Metal frame, with cold injected polyurethane foam, upholstered.

2. SEAT :

Seat in plywood padded with sponge and upholstered

3. MECHANISM :

Height adjustable

4. GAS LIFT :

- Height adjustable, chromed finish
- Height adjustable, black finish

5. BASE :

- Polished aluminium 5 spoke base, Ø 670mm
- Polyamide 5 spoke base, Ø 640mm, black finish

6. CASTORS/FEET :

- Ø 50mm self-braking castors, or soft self-braking castors, black finish
- h. 61mm polyamide glides, black finish
- Ø 50mm, soft self-locking castors, black finish.

1. DOSSIER :

Châssis en métal, rembourré avec mousse polyuréthane moulé à froid, tapissé.

2. ASSISE :

Assise en multipli de bois, rembourrée de mousse et revêtue

3. MECANISME :

Réglable en hauteur

4. VERIN A GAZ :

- Réglable en hauteur, finition chromée
- Réglable en hauteur, finition noir

5. PIÈTEMENT :

- Piètement 5 branches alu poli, Ø 670mm
- Piètement 5 branches en polyamide, Ø 640mm, finition noir

6. ROULETTES/PATINS :

- Roulettes Ø 50mm autofreinantes ou autofreinantes et gommées, finition noir
- Patins en polyamide, h. 61mm, finition noir
- Roulettes Ø 50mm, autobloquantes gommées, finition noir.

1. RÜCKENLEHNE :

Metalstruktur, mit kalt geschäumten Polyurethan geschäumt, mit Bezug.

2. SITZ :

Sitz aus Sperrholz mit Schaumstoff ausgepolstert und Bezug

3. MECHANIK :

Sitzhöhenverstellung

4. GASFEDER :

- Sitzhöhenverstellung, verchromt
- Sitzhöhenverstellung, schwarz

5. GESTELL :

- 5-Stern Alu poliertes Fußkreuz, Ø 670mm
- 5-Stern schwarzes Polyamid Fußkreuz, Ø 640mm

6. ROLLEN/GLEITER :

- Ø 50mm gebremste, oder weiche gebremste Rollen, schwarz
- Polyamidgleiter, H. 61mm, schwarz
- Weiche Stoprollen, Ø 50mm, schwarz.

1. RESPALDO :

Estructura en metal alcohada con espuma de poliuretano inyectada a frío, tapizada.

2. ASIENTO :

Asiento en madera contrachapada acolchado con esponja y tapizado

3. MECANISMO :

Control de elevación de gas

4. GAS :

- Ajustable en altura, acabado cromado
- Ajustable en altura, acabado negro

5. BASE :

- Estrella de 5 puntas en aluminio, Ø 670mm, acabado brillante
- Estrella de 5 puntas en poliamida, Ø 640mm, acabado negro

6. RUEDAS/PIES :

- Ruedas de Ø 50mm autofrenado o autofrenado y blandas, acabado negro
- Pies en poliamida, h. 61mm, acabado negro
- Rueda de Ø 50mm, autobloqueantes blandas, acabado negro.



PILATUS

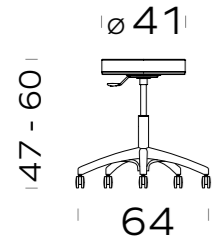

Mechanism: **SeatPlate**↑↓

Regolazione altezza
Height adjustment
Réglage en hauteur
Höhenverstellung
Ajuste de altura

IMBOTTITO, REGOLABILE IN ALTEZZA
PADDED, HEIGHT ADJUSTABLE
REMOURRÉ, RÉGLABLE EN HATEUR
GEPOLSTERT, SITZHÖHENVERSTELLUNG
ACOLCHADO, AJUSTABLE EN ALTURA



BASE BASE PIETEMET GESTELL BASE	RUOTA/PIEDINO CASTOR/FEET ROULETTES/PATINS ROLLEN/GLEITER RUEDAS/PIES	STRUTTURA STRUCTURE STRUCTURE STRUKTUR ESTRUCTURA	CODICE CODE CODE ARTIKEL CÓDIGO	KG	TESSUTI/FINITURE UPHOLSTERIES/FINISHING REVETEMENTS STOFFGRUPPE TAPICERÍAS			
					D	E	F	G
	 d.50mm autofrenanti gomme soft self-braking d.50mm d.50 mm gommées autofreinante weiche gebremste D.50 mm ruedas goma diam.50 autofreno		PI0004	5,40	184	194	204	254
	 pedini fissi alti neri black fixed glides patins fixes noirs schwarze peis fijos altos negro		RAL 9005	PI0016	5,30	199	209	219
	 d.50mm autofrenanti gomme soft self-braking d.50mm d.50 mm gommées autofreinante weiche gebremste D.50 mm ruedas goma diam.50 autofreno		PI0017	5,40	189	199	209	259
	 pedini fissi alti neri black fixed glides patins fixes noirs schwarze peis fijos altos negro		RAL 9005	PI0018	5,30	204	214	224
	 d.50mm autofrenanti gomme soft self-braking d.50mm d.50 mm gommées autofreinante weiche gebremste D.50 mm ruedas goma diam.50 autofreno		PI0001	5,40	293	303	314	368
	 pedini fissi alti neri black fixed glides patins fixes noirs schwarze peis fijos altos negro		Polished	PI0035	5,30	308	318	329

* DISPONIBILE ANCHE IN
ALSO AVAILABLE
ÉGALEMENT DISPONIBLE EN
ERHÄLTICH AUCH IN
TAMBIÉN DISPONIBLE EN

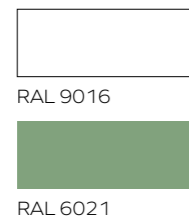

* DISPONIBILE ANCHE CON ALSO AVAILABLE WITH ÉGALEMENT DISPONIBLE AVEC ERHÄLTICH AUCH MIT TAMBIÉN DISPONIBLE CON		
	d.50 mm autofrenanti self-braking d.50mm d.50mm autofreinante gebremste D.50mm diam.50 autofreno	d.50mm autobloccanti gomme soft self-locking d.50mm d.50mm autobloquantes gommées weiche Stoprollen D.50mm
	SAME PRICE	+10€

PILATUS Stool

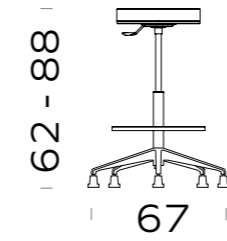

Mechanism: **SeatPlate**↑↓

Regolazione altezza
Height adjustment
Réglage en hauteur
Höhenverstellung
Ajuste de altura

IMBOTTITO, REGOLABILE IN ALTEZZA
PADDED, HEIGHT ADJUSTABLE
REMOURRÉ, RÉGLABLE EN HATEUR
GEPOLSTERT, SITZHÖHENVERSTELLUNG
ACOLCHADO, AJUSTABLE EN ALTURA



BASE BASE PIETEMET GESTELL BASE	RUOTA/PIEDINO CASTOR/FEET ROULETTES/PATINS ROLLEN/GLEITER RUEDAS/PIES	STRUTTURA STRUCTURE STRUCTURE STRUKTUR ESTRUCTURA	CODICE CODE CODE ARTIKEL CÓDIGO	KG	TESSUTI/FINITURE UPHOLSTERIES/FINISHING REVETEMENTS STOFFGRUPPE TAPICERÍAS			
					D	E	F	G
	 d.50mm autobloccanti gomme soft self-locking d.50mm d.50mm autobloquantes gommées weiche Stoprollen D.50mm diam.50 autobloquantes blandas		PI0019	7,20	195	204	216	264
	 pedini fissi alti neri black fixed glides patins fixes noirs schwarze peis fijos altos negro		RAL 9005	PI0007	7,10	210	219	231
	 d.50mm autobloccanti gomme soft self-locking d.50mm d.50mm autobloquantes gommées weiche Stoprollen D.50mm diam.50 autobloquantes blandas		PI0020	7,20	200	209	221	269
	 pedini fissi alti neri black fixed glides patins fixes noirs schwarze peis fijos altos negro		RAL 9005	PI0021	7,10	215	224	236
	 d.50mm autobloccanti gomme soft self-locking d.50mm d.50mm autobloquantes gommées weiche Stoprollen D.50mm diam.50 autobloquantes blandas		PI0022	7,20	303	312	325	377
	 pedini fissi alti neri black fixed glides patins fixes noirs schwarze peis fijos altos negro		Polished	PI0006	7,10	318	327	340

* DISPONIBILE ANCHE IN
ALSO AVAILABLE
ÉGALEMENT DISPONIBLE EN
ERHÄLTICH AUCH IN
TAMBIÉN DISPONIBLE EN

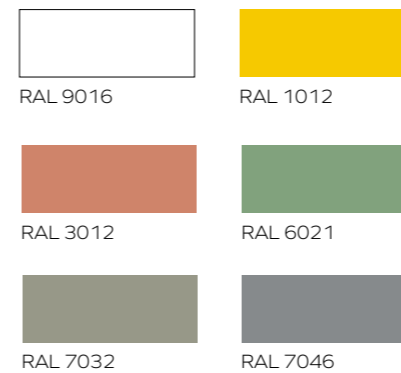

OPZIONE OPTIONALS OPTIONS OPTIONEN OPCIONES	VARIANTE VARIANT VARIANTE VARIANTE	CODICE CODE CODE ARTIKEL CÓDIGO	KG	PREZZO PRICE PRIX PREIS PRECIO
	Anello poggiapiedi in alluminio Aluminium footrest ring Appui-pieds circulaire en aluminium Ringfußstütze aus Aluminium Reposapiés anello en aluminio	XP004	1,20	106
	per base alluminio for polished alu base pour piétement alu poli zu Alu-Fußkreuz por base aluminio	XP006	1,10	68
	per base poliamide for polyamide base pour piétement polyamide zu Polyamid Fußkreuz por base poliamide	XP005	1,10	49

PILATUS

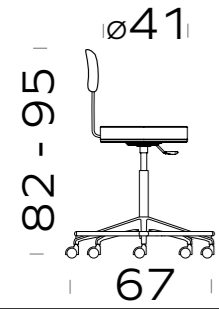

IMBOTTITO, REGOLABILE IN ALTEZZA, CON SCHIENALE
 PADDED, HEIGHT ADJUSTABLE, WITH BACKREST
 REMBOURRÉ, RÉGLABLE EN HATEUR, AVEC DOSSIER
 GEPOLSTERT, SITZHÖHENVERSTELLUNG, MIT RÜCKENLEHNE
 ACOLCHADO, AJUSTABLE EN ALTURA, CON RESPALDO

Mechanism: **SeatPlate**↑↓

Regolazione altezza
 Height adjustment
 Réglage en hauteur
 Höhenverstellung
 Ajuste de altura



BASE BASE PIÈTEMENT GESTELL BASE	RUOTA/PIEDINO CASTOR/FEET ROULETTES/PATINS ROLLEN/GLEITER RUEDAS/PIES	STRUTTURA STRUCTURE STRUCTURE STRUKTUR ESTRUCTURA	CODICE CODE ARTIKEL CÓDIGO	KG	TESSUTI/FINITURE UPHOLSTERIES/FINISHING REVÈTEMENTS STOFFGRUPPE TAPICERÍAS			
					D	E	F	G
	d.50mm autofrenanti gommate soft self-braking d.50mm d.50 mm gommées autofreinante weiche gebremste D.50 mm ruedas goma diam.50 autofreno		PI0023	10,20	307	323	333	396
	5 razze poliammide nera Ø 640 5-spoke black polyamide Ø640 5-branches polyamide noir Ø 640 5-Stern Polyamid schwarzes Fußkreuz Ø 640 estrella en poliamida negra Ø 640		piedini fissi alti neri black fixed glides patins fixes noirs schwarze peis fijos altos negro	RAL 9005	PI0024	10,10	322	338
	d.50mm autofrenanti gommate soft self-braking d.50mm d.50 mm gommées autofreinante weiche gebremste D.50 mm ruedas goma diam.50 autofreno		PI0025	10,20	312	328	338	401
	5 razze poliammide nera Ø 650 5-spoke black polyamide Ø 650 5-branches polyamide noir Ø 650 5-Stern Polyamid schwarzes Fußkreuz Ø 650 estrella en poliamida negra Ø 650		piedini fissi alti neri black fixed glides patins fixes noirs schwarze peis fijos altos negro	RAL 9005	PI0026	10,10	327	343
	d.50mm autofrenanti gommate soft self-braking d.50mm d.50 mm gommées autofreinante weiche gebremste D.50 mm ruedas goma diam.50 autofreno		PI0027	10,20	416	432	443	510
	5 razze in alluminio lucida 5-spoke polished aluminium 5 branches alu poli 5-Stern Alu poliertes Fußkreuz estrella en aluminio Pulido		piedini fissi alti neri black fixed glides patins fixes noirs schwarze peis fijos altos negro	Polished	PI0028	10,10	431	447

* DISPONIBILE ANCHE IN
 ALSO AVAILABLE
 ÉGALEMENT DISPONIBLE EN
 ERHÄLTLICH AUCH IN
 TAMBIÉN DISPONIBLE EN

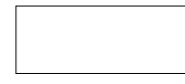

RAL 9016



RAL 6021



RAL 1012



RAL 7032



RAL 3012



RAL 7046

* DISPONIBILE ANCHE CON
 ALSO AVAILABLE WITH
 ÉGALEMENT DISPONIBLE AVEC
 ERHÄLTLICH AUCH MIT
 TAMBIÉN DISPONIBLE CON



d.50 mm autofrenanti
self-braking d.50mm
d.50mm autofreinante
gebremste D.50mm
diam.50 autofreno

SAME PRICE



d.50mm autobloccanti gommate
soft self-locking d.50mm
d.50mm autobloquantes
gommées
weiche Stoprollen D.50mm

+10€

PILATUS Stool

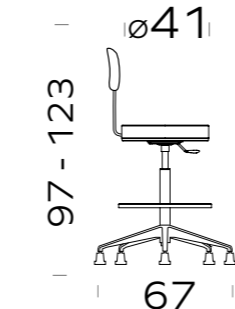

IMBOTTITO, REGOLABILE IN ALTEZZA, CON SCHIENALE
 PADDED, HEIGHT ADJUSTABLE, WITH BACKREST
 REMBOURRÉ, RÉGLABLE EN HATEUR, AVEC DOSSIER
 GEPOLSTERT, SITZHÖHENVERSTELLUNG, MIT RÜCKENLEHNE
 ACOLCHADO, AJUSTABLE EN ALTURA, CON RESPALDO

Mechanism: **SeatPlate**↑↓

Regolazione altezza
 Height adjustment
 Réglage en hauteur
 Höhenverstellung
 Ajuste de altura



BASE BASE PIÈTEMENT GESTELL BASE	RUOTA/PIEDINO CASTOR/FEET ROULETTES/PATINS ROLLEN/GLEITER RUEDAS/PIES	STRUTTURA STRUCTURE STRUCTURE STRUKTUR ESTRUCTURA	CODICE CODE ARTIKEL CÓDIGO	KG	TESSUTI/FINITURE UPHOLSTERIES/FINISHING REVÈTEMENTS STOFFGRUPPE TAPICERÍAS			
					D	E	F	G
	d.50mm autobloccanti gommate soft self-locking d.50mm d.50mm autobloquantes gommées weiche Stoprollen D.50mm diam.50 autobloquantes blandas		PI0029	12,00	318	333	345	406
	5 razze poliammide nera Ø 640 5-spoke black polyamide Ø640 5-branches polyamide noir Ø 640 5-Stern Polyamid schwarzes Fußkreuz Ø 640 estrella en poliamida negra Ø 640		piedini fissi alti neri black fixed glides patins fixes noirs schwarze peis fijos altos negro	RAL 9005	PI0030	11,90	333	348
	d.50mm autobloccanti gommate soft self-locking d.50mm d.50mm autobloquantes gommées weiche Stoprollen D.50mm diam.50 autobloquantes blandas		PI0031	12,00	323	338	350	411
	5 razze poliammide nera Ø 650 5-spoke black polyamide Ø 650 5-branches polyamide noir Ø 650 5-Stern Polyamid schwarzes Fußkreuz Ø 650 estrella en poliamida negra Ø 650		piedini fissi alti neri black fixed glides patins fixes noirs schwarze peis fijos altos negro	RAL 9005	PI0032	11,90	338	353
	d.50mm autobloccanti gommate soft self-locking d.50mm d.50mm autobloquantes gommées weiche Stoprollen D.50mm diam.50 autobloquantes blandas		PI0033	12,00	426	441	454	519
	5 razze in alluminio lucida 5-spoke polished aluminium 5 branches alu poli 5-Stern Alu poliertes Fußkreuz estrella en aluminio Pulido		piedini fissi alti neri black fixed glides patins fixes noirs schwarze peis fijos altos negro	Polished	PI0034	11,90	441	456

* DISPONIBILE ANCHE IN
 ALSO AVAILABLE
 ÉGALEMENT DISPONIBLE EN
 ERHÄLTLICH AUCH IN
 TAMBIÉN DISPONIBLE EN



RAL 9016



RAL 3012



RAL 7032



RAL 1012



RAL 6021



RAL 7046

OPZIONE OPTIONALS OPTIONS OPTIONEN OPCIONES	VARIANTE VARIANT VARIANTE VARIANTE VARIANTE	CODICE CODE ARTIKEL CÓDIGO	KG	PREZZO PRICE PRIX PREIS PRECIO
	Anello poggipiedi in alluminio Aluminium footrest ring Appui-pieds circulaire en aluminium Ringfußstütze aus Aluminium Reposapiés anello en aluminio	XP004	1,20	106
	per base alluminio for polished alu base pour piètement alu poli zu Alu-Fußkreuz por base aluminio	XP006	1,10	68
	per base poliammide for polyamide base pour piètement polyamide zu Polyamid Fußkreuz por base poliamide	XP005	1,10	49

EDGAR

idea: *Pietro Lovato*



TECHNICAL INFORMATION

1.TOP:
Piano in MDF, sp. 28mm,
80x80cm o 130x130cm, finitura
laccata

2.BASE:

- Gamba a cono in acciaio, h.
32 cm, finitura laccata
- Gamba a cono in acciaio, h.
74 cm, finitura laccata
- Gamba a cono in acciaio, h.
100 cm, finitura laccata
- Gamba a doppio cono in
acciaio, h. 74 cm, finitura
laccata

1.TOP:
28mm thk MDF top, 80x80cm or
130x130cm lacquered finish

2.BASE:

- Steel cone Base, h.32 cm,
lacquered finish
- Steel cone Base, h.74 cm,
lacquered finish
- Steel cone Base, h.100 cm,
lacquered finish
- Steel double-cone Base, h.74
cm, lacquered finish

1.TOP:
Plateau en MDF, épaisseur
28mm, 80x80cm ou 130x130cm,
finition laqué

2.PIÈTEMENT:

- Piètement tulipe en acier, h.
32 cm, finition laqué
- Piètement tulipe en acier, h. 74
cm, finition laqué
- Piètement tulipe en acier,
h.100 cm, finition laqué
- Piètement double tulipe en
acier, h.74 cm, finition laqué

1.TOP:
Lackierte MDF Tischplatte,
D. 28 mm, 80x80 cm oder
130x130 cm

2.GESTELL:

- Stahl Tellerfuß, h. 32 cm,
lackiert
- Stahl Tellerfuß, h. 74 cm,
lackiert
- Stahl Tellerfuß, h. 100 cm,
lackiert
- Doppel Stahl Tellerfuß, h. 74
cm, lackiert

1.TOP:
Top en MDF lacado sp. 28mm,
base de acero lacado. 80x80 cm
/ 130x130 cm

2.PIERNA:









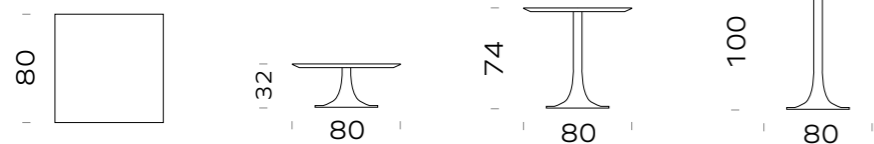

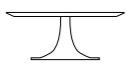

- Pierna a cono altura 32 cm
- Pierna a cono altura 74 cm
- Pierna a cono altura 100 cm
- Pierna a doble cono altura
74 cm

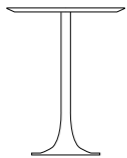

EDGAR

PIANO IN MDF LACCATO SP 28MM, BASE IN ACCIAIO LACCATA, 80x80 CM
 MDF LACQUERED TOP, THK 28MM, LACQUERED STEEL BASE, 80x80 CM
 PLATEAU EN MDF LAQUÉ, ÉP. 28MM, PIETEMENT EN ACIER, 80x80 CM
 LACKIERTE MDF TISCHPLATTE, D. 28MM, STAHLFUß LACKIERT, 80x80 CM
 TABLERO EN MDF LACADO, ESP 28MM, ESTRUCTURA EN ACERO LACADO, 80x80 CM



BASE BASE PIETEMENT GESTELL BASE	RUOTA/PIEDINO CASTOR/FEET ROULETTES/PATINS ROLLEN/GLEITER RUEDAS/PIES	CODICE CODE ARTIKEL CÓDIGO	KG	RAL*	PREZZO* PRICE PRIX PREIS PRECIO
 altezza 32 cm h. 32 cm haut. 32 cm H. 32 cm h 32 cm	 feltrini felts feutres Filzgleiter feltros	ED0003	20,50	 RAL 9005	1870
				 RAL 9010	
 altezza 74 cm h. 74 cm haut. 74 cm H. 74 cm h 74 cm	 feltrini felts feutres Filzgleiter feltros	ED0001	32,60	 RAL 9005	2171
				 RAL 9010	
 altezza 100 cm h. 100 cm haut. 100 cm H. 100 cm h 100 cm	 feltrini felts feutres Filzgleiter feltros	ED0002	33,50	 RAL 9005	2185
				 RAL 9010	



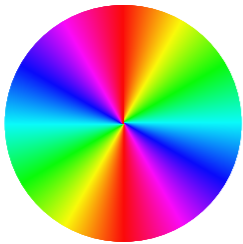
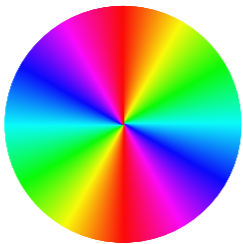

* PREZZO E RAL DISPONIBILI SU RICHIESTA
 PRICE AND RAL AVAILABLE ON REQUEST
 PRIX ET RAL DISPONIBLE SUR DEMANDE
 PREIS UND RAL NACH WUNSCH ERHÄLTlich
 RAL Y PRECIO DISPONIBLES A PETICIÓN

BASE RAL	MDF RAL
DISPONIBILE IN UN COLORE RAL A SCELTA AVAILABLE IN A SELECTED RAL COLOR DISPONIBLE DANS UNE COULEUR RAL AU CHOIX ERHÄLTlich IN AUSWÄHLBARE RAL FARBEN DISPONIBLE EN UN RAL A ELECCIÓN	DISPONIBILE IN UN COLORE RAL A SCELTA AVAILABLE IN A SELECTED RAL COLOR DISPONIBLE DANS UNE COULEUR RAL AU CHOIX ERHÄLTlich IN AUSWÄHLBARE RAL FARBEN DISPONIBLE EN UN RAL A ELECCIÓN
	

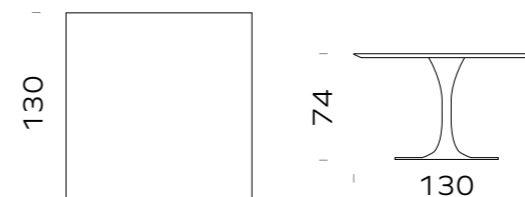
EDGAR

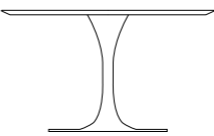
PIANO IN MDF LACCATO SP 28MM, BASE IN ACCIAIO LACCATA, 130x130 CM
 MDF LACQUERED TOP, THK 28MM, LACQUERED STEEL BASE, 130x130 CM
 PLATEAU EN MDF LAQUÉ, ÉP. 28MM, PIETEMENT EN ACIER, 130x130 CM
 LACKIERTE MDF TISCHPLATTE, D. 28MM, STAHLFUß LACKIERT, 130x130 CM
 TABLERO EN MDF LACADO, ESP 28MM, ESTRUCTURA EN ACERO LACADO, 130x130 CM



BASE BASE PIETEMENT GESTELL BASE	RUOTA/PIEDINO CASTOR/FEET ROULETTES/PATINS ROLLEN/GLEITER RUEDAS/PIES	CODICE CODE ARTIKEL CÓDIGO	KG	RAL*	PREZZO* PRICE PRIX PREIS PRECIO
 doppio cono altezza 74 cm double-cone h. 74 cm double tulipe haut. 74 cm Doppeltellerfuß H. 74 cm pata a doble cono 74 cm	 feltrini felts feutres Filzgleiter feltros	ED0004	77,50	 RAL 9005	2980
				 RAL 9010	

* PREZZO E RAL DISPONIBILI SU RICHIESTA
 PRICE AND RAL AVAILABLE ON REQUEST
 PRIX ET RAL DISPONIBLE SUR DEMANDE
 PREIS UND RAL NACH WUNSCH ERHÄLTlich
 RAL Y PRECIO DISPONIBLES A PETICIÓN

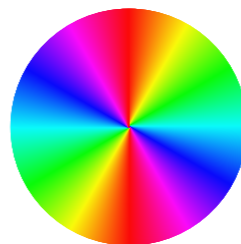
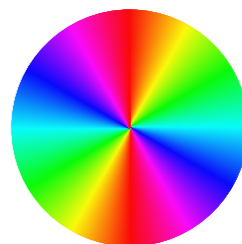
BASE RAL	MDF RAL
DISPONIBILE IN UN COLORE RAL A SCELTA AVAILABLE IN A SELECTED RAL COLOR DISPONIBLE DANS UNE COULEUR RAL AU CHOIX ERHÄLTlich IN AUSWÄHLBARE RAL FARBEN DISPONIBLE EN UN RAL A ELECCIÓN	DISPONIBILE IN UN COLORE RAL A SCELTA AVAILABLE IN A SELECTED RAL COLOR DISPONIBLE DANS UNE COULEUR RAL AU CHOIX ERHÄLTlich IN AUSWÄHLBARE RAL FARBEN DISPONIBLE EN UN RAL A ELECCIÓN
	

NABUCCO

idea: *Pietro Lovato*



TECHNICAL INFORMATION

1.TOP:
Piano in MDF, sp. 28mm,
90x110cm, 100x160cm o
130x300cm, finitura laccata

2.BASE:

- Gamba a cono in acciaio, h. 32 cm, finitura laccata
- Gamba a cono in acciaio, h. 74 cm, finitura laccata
- Gamba a cono in acciaio, h. 100 cm, finitura laccata
- Gamba a doppio cono in acciaio, h. 74 cm, finitura laccata

1.TOP:
28mm thk MDF top, 90x110cm,
100x160cm or 130x300cm
lacquered finish

2.BASE:

- Steel cone Base, h.32 cm, lacquered finish
- Steel cone Base, h.74 cm, lacquered finish
- Steel cone Base, h.100 cm, lacquered finish
- Steel double-cone Base, h.74 cm, lacquered finish

1.TOP:
Plateau en MDF, épaisseur
28mm, 90x110cm, 100x160cm
ou 130x300cm, finition laqué

2.PIÈTEMENT:

- Piètement tulipe en acier, h. 32 cm, finition laqué
- Piètement tulipe en acier, h. 74 cm, finition laqué
- Piètement tulipe en acier, h.100 cm, finition laqué
- Piètement double tulipe en acier, h.74 cm, finition laqué

1.TOP:
Lackierte MDF Tischplatte,
D. 28 mm, 90x110 cm, 100x160
cm oder 130x300 cm

2.GESTELL:

- Stahl Tellerfuß, h 32 cm, lackiert
- Stahl Tellerfuß, h 74 cm, lackiert
- Stahl Tellerfuß, h 100 cm, lackiert
- Doppel Stahl Tellerfuß, h 74 cm, lackiert

1.TOP:
Top en MDF lacado sp. 28mm,
base de acero lacado. 90x110
cm / 100x160 cm / 130x300 cm

2.PIERNAS:







- Pierna a cono altura 32 cm
- Pierna a cono altura 74 cm
- Pierna a cono altura 100 cm
- Pierna a doble cono altura 74 cm

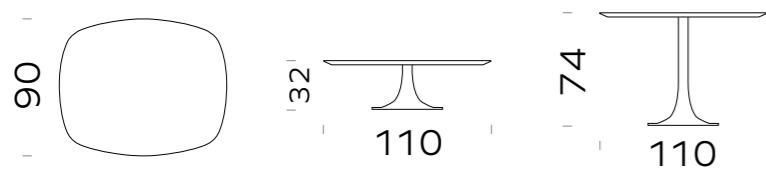

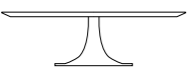
NABUCCO

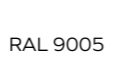
PIANO IN MDF LACCATO SP. 28MM, BASE IN ACCIAIO LACCATA, 110x90 CM
 MDF LACQUERED TOP, THK 28MM, LACQUERED STEEL BASE, 110x90 CM
 PLATEAU EN MDF LAQUÉ, ÉP. 28MM, PIETEMENT EN ACIER, 110x90 CM
 LACKIERTE MDF TISCHPLATTE, D. 28MM, STAHLFUß LACKIERT, 110x90 CM
 TABLERO EN MDF LACADO, ESP 28MM, ESTRUCTURA EN ACERO LACADO, 110x90 CM

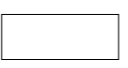

BASE BASE PIETEMENT GESTELL BASE	RUOTA/PIEDINO CASTOR/FEET ROULETTES/PATINS ROLLEN/GLEITER RUEDAS/PIES	CODICE CODE CODE ARTIKEL CÓDIGO	KG	RAL*	PREZZO* PRICE PRIX PREIS PRECIO
 altezza 32 cm h. 32 cm haut. 32 cm H. 32 cm h 32 cm	 feltrini felts feutres Filzgleiter fieltros	NB0002	24,40	 RAL 9005	1955
				 RAL 9010	
 altezza 74 cm h. 74 cm haut. 74 cm H. 74 cm h 74 cm	 feltrini felts feutres Filzgleiter fieltros	NB0001	36,50	 RAL 9005	2197
				 RAL 9010	

* PREZZO E RAL DISPONIBILI SU RICHIESTA
 PRICE AND RAL AVAILABLE ON REQUEST
 PRIX ET RAL DISPONIBLE SUR DEMANDE
 PREIS UND RAL NACH WUNSCH ERHÄLTlich
 RAL Y PRECIO DISPONIBLES A PETICIÓN

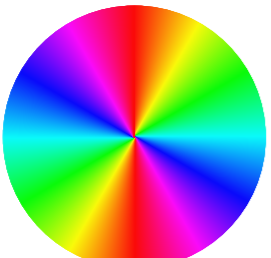
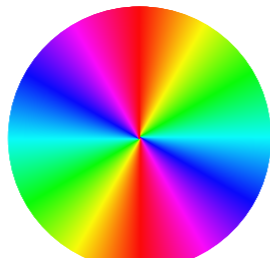
BASE RAL	MDF RAL
DISPONIBILE IN UN COLORE RAL A SCELTA AVAILABLE IN A SELECTED RAL COLOR DISPONIBLE DANS UNE COULEUR RAL AU CHOIX ERHÄLTlich IN AUSWÄHLBARE RAL FARBEN DISPONIBLE EN UN RAL A ELECCIÓN	DISPONIBILE IN UN COLORE RAL A SCELTA AVAILABLE IN A SELECTED RAL COLOR DISPONIBLE DANS UNE COULEUR RAL AU CHOIX ERHÄLTlich IN AUSWÄHLBARE RAL FARBEN DISPONIBLE EN UN RAL A ELECCIÓN
	

NABUCCO

PIANO IN MDF LACCATO SP. 28MM, BASE IN ACCIAIO LACCATA, 160x100 CM
 MDF LACQUERED TOP, THK 28MM, LACQUERED STEEL BASE, 160x100 CM
 PLATEAU EN MDF LAQUÉ, ÉP. 28MM, PIETEMENT EN ACIER, 160x100 CM
 LACKIERTE MDF TISCHPLATTE, D. 28MM, STAHLFUß LACKIERT, 160x100 CM
 TABLERO EN MDF LACADO, ESP 28MM, ESTRUCTURA EN ACERO LACADO, 160x100 CM

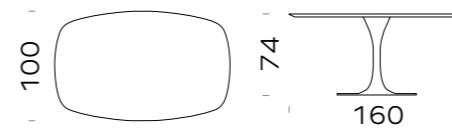

BASE BASE PIETEMENT GESTELL BASE	RUOTA/PIEDINO CASTOR/FEET ROULETTES/PATINS ROLLEN/GLEITER RUEDAS/PIES	CODICE CODE CODE ARTIKEL CÓDIGO	KG	RAL*	PREZZO* PRICE PRIX PREIS PRECIO
 doppio cono altezza 74 cm double-cone h. 74 cm double tulipe haut. 74 cm Doppelstellerfuß H. 74 cm pata a doble cono 74 cm	 feltrini felts feutres Filzgleiter fieltros	NB0003	71,40	 RAL 9005	2951
				 RAL 9010	

PIANO IN MDF LACCATO SP. 28MM, BASE IN ACCIAIO LACCATA, 300x130 CM
 MDF LACQUERED TOP, THK 28MM, LACQUERED STEEL BASE, 300x130 CM
 PLATEAU EN MDF LAQUÉ, ÉP. 28MM, PIETEMENT EN ACIER, 300x130 CM
 LACKIERTE MDF TISCHPLATTE, D. 28MM, STAHLFUß LACKIERT, 300x130 CM
 TABLERO EN MDF LACADO, ESP 28MM, ESTRUCTURA EN ACERO LACADO, 300x130 CM

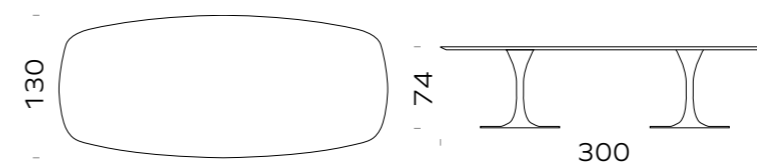

BASE BASE PIETEMENT GESTELL BASE	RUOTA/PIEDINO CASTOR/FEET ROULETTES/PATINS ROLLEN/GLEITER RUEDAS/PIES	CODICE CODE CODE ARTIKEL CÓDIGO	KG	RAL*	PREZZO* PRICE PRIX PREIS PRECIO
 doppio cono altezza 74 cm double-cone h. 74 cm double tulipe haut. 74 cm Doppelstellerfuß H. 74 cm pata a doble cono 74 cm	 feltrini felts feutres Filzgleiter fieltros	NB0004	115,20	 RAL 9005	5715
				 RAL 9010	

* PREZZO E RAL DISPONIBILI SU RICHIESTA
 PRICE AND RAL AVAILABLE ON REQUEST
 PRIX ET RAL DISPONIBLE SUR DEMANDE
 PREIS UND RAL NACH WUNSCH ERHÄLTlich
 RAL Y PRECIO DISPONIBLES A PETICIÓN

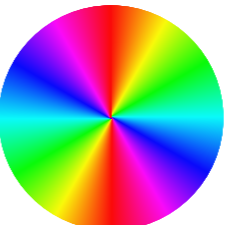
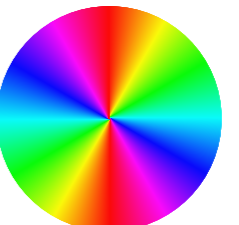
BASE RAL	MDF RAL
DISPONIBILE IN UN COLORE RAL A SCELTA AVAILABLE IN A SELECTED RAL COLOR DISPONIBLE DANS UNE COULEUR RAL AU CHOIX ERHÄLTlich IN AUSWÄHLBARE RAL FARBEN DISPONIBLE EN UN RAL A ELECCIÓN	DISPONIBILE IN UN COLORE RAL A SCELTA AVAILABLE IN A SELECTED RAL COLOR DISPONIBLE DANS UNE COULEUR RAL AU CHOIX ERHÄLTlich IN AUSWÄHLBARE RAL FARBEN DISPONIBLE EN UN RAL A ELECCIÓN
	

OTELLO

idea: *Pietro Lovato*



TECHNICAL INFORMATION

1.TOP:
Piano in MDF, sp. 28mm,
80x80cm o 130x130cm, finitura
laccata

2.BASE:

- Gamba a cono in acciaio, h.
32 cm, finitura laccata
- Gamba a cono in acciaio, h.
74 cm, finitura laccata
- Gamba a cono in acciaio, h.
100 cm, finitura laccata
- Gamba a doppio cono in
acciaio, h. 74 cm, finitura
laccata

1.TOP
28mm thk MDF top, 80x80cm or
130x130cm lacquered finish

2.BASE:

- Steel cone Base, h.32 cm,
lacquered finish
- Steel cone Base, h.74 cm,
lacquered finish
- Steel cone Base, h. 100 cm,
lacquered finish
- Steel double-cone Base, h.74
cm, lacquered finish

1.TOP:
Plateau en MDF, épaisseur
28mm, 80x80cm ou 130x130cm,
finition laqué

2.PIÈTEMENT:

- Piètement tulipe en acier, h.
32 cm, finition laqué
- Piètement tulipe en acier, h. 74
cm, finition laqué
- Piètement tulipe en acier,
h.100 cm, finition laqué
- Piètement double tulipe en
acier, h.74 cm, finition laqué

1.TOP:
Lackierte MDF Tischplatte,
D. 28 mm, 80x80 cm oder
130x130 cm

2.GESTELL:

- Stahl Tellerfuß, h 32 cm,
lackiert
- Stahl Tellerfuß, h 74 cm,
lackiert
- Stahl Tellerfuß, h 100 cm,
lackiert
- Doppel Stahl Tellerfuß, h 74
cm, lackiert

1.TOP:
Top en MDF lacado sp. 28mm,
base de acero lacado. 80x80 cm
/ 130x130 cm

2.PIERNA:

- Pierna a cono altura 32 cm
- Pierna a cono altura 74 cm
- Pierna a cono altura 100 cm
- Pierna a doble cono altura
74 cm



OTELLO

PIANO IN MDF LACCATO DP 28MM, BASE IN ACCIAIO LACCATA, 80 CM
 MDF LACQUERED TOP, THK 28MM, LACQUERED STEEL BASE, 80 CM
 PLATEAU EN MDF LAQUÉ, ÉP. 28MM, PIETEMENT EN ACIER, 80 CM
 LACKIERTE MDF TISCHPLATTE, D. 28MM, STAHLFUß LACKIERT, 80 CM
 TABLERO EN MDF LACADO, ESP 28MM, ESTRUCTURA EN ACERO LACADO, 80 CM

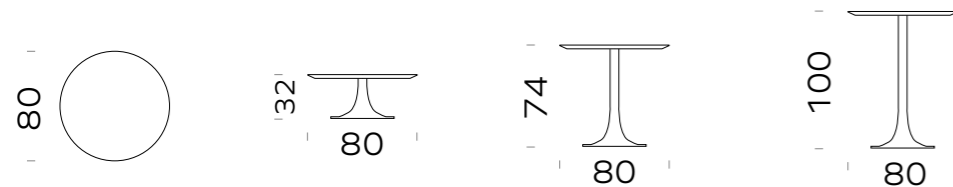

BASE BASE PIETEMENT GESTELL BASE	RUOTA/PIEDINO CASTOR/FEET ROULETTES/PATINS ROLLEN/GLEITER RUEDAS/PIES	CODICE CODE CODE ARTIKEL CÓDIGO	KG	RAL*	PREZZO* PRICE PRIX PREIS PRECIO
 altezza 32 cm h. 32 cm haut. 32 cm H. 32 cm h 32 cm	 feltrini felts feutres Filzgleiter fietros	OL0003	17,80	 RAL 9005 RAL 9010	1831
 altezza 74 cm h. 74 cm haut. 74 cm H. 74 cm h 74 cm	 feltrini felts feutres Filzgleiter fietros	OL0001	29,80	 RAL 9005 RAL 9010	2132
 altezza 100 cm h. 100 cm haut. 100 cm H. 100 cm h 100 cm	 feltrini felts feutres Filzgleiter fietros	OL0002	30,70	 RAL 9005 RAL 9010	2146

* PREZZO E RAL DISPONIBILI SU RICHIESTA
 PRICE AND RAL AVAILABLE ON REQUEST
 PRIX ET RAL DISPONIBLE SUR DEMANDE
 PREIS UND RAL NACH WUNSCH ERHÄLTlich
 RAL Y PRECIO DISPONIBLES A PETICIÓN

BASE RAL	MDF RAL
DISPONIBILE IN UN COLORE RAL A SCELTA AVAILABLE IN A SELECTED RAL COLOR DISPONIBLE DANS UNE COULEUR RAL AU CHOIX ERHÄLTlich IN AUSWÄHLBARE RAL FARBEN DISPONIBILE EN UN RAL A ELECCIÓN	DISPONIBILE IN UN COLORE RAL A SCELTA AVAILABLE IN A SELECTED RAL COLOR DISPONIBLE DANS UNE COULEUR RAL AU CHOIX ERHÄLTlich IN AUSWÄHLBARE RAL FARBEN DISPONIBILE EN UN RAL A ELECCIÓN

OTELLO

PIANO IN MDF LACCATO DP 28MM, BASE IN ACCIAIO LACCATA, 130 CM
 MDF LACQUERED TOP, THK 28MM, LACQUERED STEEL BASE, 130 CM
 PLATEAU EN MDF LAQUÉ, ÉP. 28MM, PIETEMENT EN ACIER, 130 CM
 LACKIERTE MDF TISCHPLATTE, D. 28MM, STAHLFUß LACKIERT, 130 CM
 TABLERO EN MDF LACADO, ESP 28MM, ESTRUCTURA EN ACERO LACADO, 130 CM

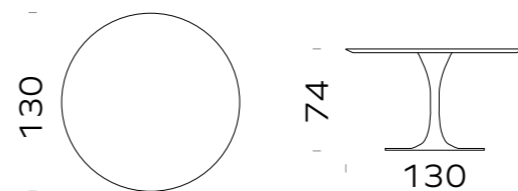

BASE BASE PIETEMENT GESTELL BASE	RUOTA/PIEDINO CASTOR/FEET ROULETTES/PATINS ROLLEN/GLEITER RUEDAS/PIES	CODICE CODE CODE ARTIKEL CÓDIGO	KG	RAL*	PREZZO* PRICE PRIX PREIS PRECIO
 doppio cono altezza 74 cm double-cone h. 74 cm double tulipe haut. 74 cm Doppeltellerfuß H. 74 cm pata a doble cono 74 cm	 feltrini felts feutres Filzgleiter fietros	OL0004	70,00	 RAL 9005 RAL 9010	2906

* PREZZO E RAL DISPONIBILI SU RICHIESTA
 PRICE AND RAL AVAILABLE ON REQUEST
 PRIX ET RAL DISPONIBLE SUR DEMANDE
 PREIS UND RAL NACH WUNSCH ERHÄLTlich
 RAL Y PRECIO DISPONIBLES A PETICIÓN

BASE RAL	MDF RAL
DISPONIBILE IN UN COLORE RAL A SCELTA AVAILABLE IN A SELECTED RAL COLOR DISPONIBLE DANS UNE COULEUR RAL AU CHOIX ERHÄLTlich IN AUSWÄHLBARE RAL FARBEN DISPONIBILE EN UN RAL A ELECCIÓN	DISPONIBILE IN UN COLORE RAL A SCELTA AVAILABLE IN A SELECTED RAL COLOR DISPONIBLE DANS UNE COULEUR RAL AU CHOIX ERHÄLTlich IN AUSWÄHLBARE RAL FARBEN DISPONIBILE EN UN RAL A ELECCIÓN

	ALIA C	ALIA TOP	ALIA K	ALIA LOUNGE	ARTURO	ATTIVA	AURELIA	BOHEME	CARDINALE	CARMEN	CRONO	CRONO 24	CUBIX	DAFNE	DAMA	DAMA R	DRESSCHAIR	DRESSCHAIR R	ECOCHAIR	ELETTA	FLEXA	FORMA	GIADA	GIUNONE	HOOP	IRIS	ISY	MOVING73 TASK	MOVING73 TASK STOOL	OTAVO Q	OTAVO R	PILATUS	R&G	SLIM	TOSCA	VIVA	ZIP				
D TARGET																																									
D EXPO																																									
D KING																																									
D RADIO																																									
D SILVIA																																									
E ROCCIA																																									
E ONE																																									
E CONVERT																																									
E DEMETRA																																									
E JEWEL																																									
F MINI MELANGE																																									
F PLATINUM																																									
F XTREME																																									
G CYCLE																																									
G LEATHER																																									
G LANEEL MELANGE																																									
H COLUMBIA																																									
L LINE																																									
M RETE ATTIVA																																									
M SPIDER																																									
N MICRO																																									
N TARGET																																									



Tabella sinottica dei rivestimenti, sedia per sedia
 Synoptic table of coverings, chair by chair
 Tableau synoptique des revêtements chaise par chaise
 Übersichtstabelle passende Auspolsterungen je Stuhlserie
 Tabla sinóptica de revestimientos, silla por silla



Dal 1980 MOVING progetta e realizza sedie ergonomiche di alta qualità nel suo stabilimento di Trissino, Vicenza. La tradizione artigianale e l'approccio innovativo caratterizzano ogni prodotto che l'azienda propone per l'ufficio, la casa e gli spazi comuni, perchè il benessere delle persone incontri la funzionalità e l'estetica.

Since 1980 MOVING has designed and manufactured high quality seats at their facilities in Trissino, in the Northeast Italy. Traditional craftsmanship and an innovation-driven approach characterise the brand's products, a wide range of solutions for office spaces, home and public spaces, so that wellbeing meets functionality and aesthetics.

Depuis 1980, MOVING conçoit et fabrique des sièges de haute qualité dans l'usine de Trissino, dans le nord-est de l'Italie. L'artisanat traditionnel et une approche axée sur l'innovation caractérisent les produits de la marque, comprenant une large gamme de solutions pour les espaces de bureau, la maison et les espaces publics, afin que le bien-être rencontre la fonctionnalité et l'esthétique.

Seit 1980 entwickelt und produziert Moving in seinem Werk in Trissino, Vicenza, hochwertige, ergonomische Stühle. Die handwerkliche Tradition und der innovative Ansatz, kennzeichnen jedes Produkt das das Unternehmen für Büro, Wohnbereich und Gemeinschaftsräume anbietet, damit das Wohlbefinden des Benutzers Funktionalität und Ästhetik trifft.

Desde 1980, Moving diseña y produce sillas ergonómicas de alta calidad en su planta de Trissino, Vicenza. La tradición artesanal y el enfoque innovador caracterizan todos los productos que la empresa ofrece para la oficina, el hogar y otros entornos donde el bienestar de las personas se encuentra con la funcionalidad y la estética.

movingchairs.it

MOVING srl
Via dell'Artigianato 1
Trissino (VI) Italy
T +39 0445 490777
italia@moving.vi.it
export@moving.vi.it

movingchairs.it